



GENERATIONS OF KNOWLEDGE  
AT YOUR SERVICE



## TRAILER PARTS & ACCESSORIES

PRODUCT CATALOGUE

2020



## TRAILER

Genfitt are a leading supplier of quality parts and spares for all types of Trailers for both agricultural & general haulage purposes. We offer a full range of branded trailer hitches such as Al-Ko Kober, Bradley and Knott-Avonride. We supply a range of Towing Hitches, Jockey Wheels, Box Jacks and Braking equipment in both branded and generic models depending on the application. We stock a wide selection of Axles and Wheels to cater for all your requirements in car/jeep drawn road trailers.

We have a huge selection of Trailer Body Parts such as Hinges, Gudgeons, Ramp Springs, Ramp Fasteners and Anti-Luces. We supply these items to various large manufacturers and also offer them for resale as replacement parts.

Here at Genfitt we pride ourselves on keeping on top of new innovations and safety features in the industry. With this in mind we offer Hydrasafe Braking systems, Air Braking components and Scharmuller Spoon Hitches to name but a few.

Our trailer range is complemented by a huge number of supplementary products which can be found on a range of trailers serving different purposes. These include our LED lighting range, Safety signage, Hydraulic and Hardware ranges. A selection of these are shown in the Additional Trailer Products section (P87).

We have a number of diagrams and suitability charts to help you identify the products that complement each other along with images to help you decide on the one which suits you best.

For further information, images and technical details on all products listed in this catalogue please visit our website [www.genfitt.ie](http://www.genfitt.ie) or contact your sales representative.

Terms & conditions please visit [www.genfitt.ie](http://www.genfitt.ie)

---

## TABLE OF CONTENTS

TRAILER HITCHES	<b>02</b>	TRAILER BODY PARTS	<b>73</b>
TOWING HITCHES	<b>19</b>	BOAT TRAILER PARTS	<b>83</b>
TRAILER JOCKEY WHEELS	<b>26</b>	TRAILER MACHINE RAMPS	<b>86</b>
TRAILER BOX JACKS	<b>31</b>	ADDITIONAL TRAILER CATALOGUE PRODUCTS	<b>87</b>
TRAILER BRAKING	<b>33</b>	DATA SHEETS	<b>96</b>
TRAILER AIR BRAKING	<b>36</b>	INDEX	<b>108</b>
TRAILER AXLES, HUBS SUSPENSIONS & ACCESSORIES	<b>45</b>	ITEM CODE INDEX	<b>112</b>
TRAILER WHEELS, KITS, STUDS, NUTS, TYRES & TUBES	<b>65</b>		

## TRAILER HITCHES

## AL-KO AK7 750KG COUPLING HEAD

**AL-KO**  
 QUALITY FOR LIFE

- Pressed steel coupling head for unbraked trailers
- Variant: to fit 50mm box section drawtube
- Maximum towing capacity: 750kg

CODE	CAPACITY	MAX NOSE WEIGHT	LENGTH	HOLE DIAMETER	HOLE PATTERN	OE REF
G18118	750kg	75kg	265mm	12mm	90mm	1224334

## ADDITIONAL IMAGES



## BRADLEY D201 UNBRAKED HITCH

**BRADLEY**  
 AN AL-KO COMPANY

- Bradley unbraked hitch
- Variant: 2 bolt
- Ball head: 50mm
- Maximum towing capacity: 750kg (within the EU)

CODE	CAPACITY	MAX NOSE WEIGHT	LENGTH	HOLE DIAMETER	HOLE PATTERN	OE REF
G3027	750kg	100kg	240mm	14mm	80mm	D201C2

## BRADLEY D30 SPRING DAMPED HITCH

**BRADLEY**  
 AN AL-KO COMPANY

- Spring damped hitch
- Variant: 4 bolt
- Ball head: 50mm
- Maximum towing capacity: 1,500kg

CODE	CAPACITY	MAX NOSE WEIGHT	LENGTH	HOLE DIAMETER	HOLE PATTERN	OE REF
G3032A	1,500kg	75kg	405mm	14mm	140 x 60mm	D30M2

## BRADLEY D40 SPRING DAMPED HITCH



- Spring damped hitch
- Variant: 4 bolt
- Ball head: 50mm
- Maximum towing capacity: 2,250kg

CODE	CAPACITY	MAX NOSE WEIGHT	LENGTH	HOLE DIAMETER	HOLE PATTERN	OE REF
G3033A	2,250kg	100kg	405mm	14mm	140 x 60mm	D40M2

## BRADLEY D60 SPRING DAMPED HITCH



- Spring damped hitch
- Variant: 4 bolt
- Ball head: 50mm
- Maximum towing capacity: 3,000kg

CODE	CAPACITY	MAX NOSE WEIGHT	LENGTH	HOLE DIAMETER	HOLE PATTERN	OE REF
G3034	3,000kg	100kg	430mm	14mm	140 x 75mm	D60M2

## BRADLEY HU3 2000KG HYDRATOW DELTA HITCH



### ADDITIONAL IMAGES

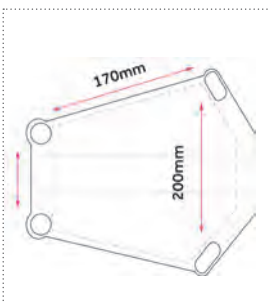

- Heavy duty coupling, built to withstand all the rigours of all industrial and commercial use
- Cast iron body has been designed for maximum strength and fits on top of or inside the A-frame
- Variant: coupling only
- Ball head: 50mm
- Maximum towing capacity: 2,000kg
- 71/320 approval: CD87/002
- 94/20 approval: e11\*94/20\*0106\*00

CODE	CAPACITY	MAX NOSE WEIGHT	LENGTH	HOLE DIAMETER	HOLE PATTERN	OE REF
G3052	1,300 - 2,000kg	100kg	700mm	14mm	SEE DIAGRAM	EH20MF

## BRADLEY HU3 2700KG HYDRATOW DELTA HITCH

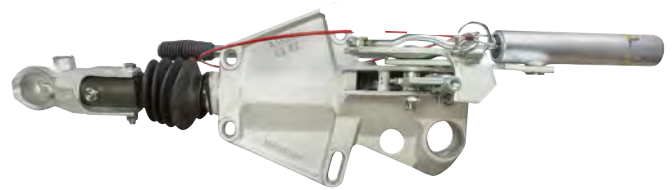

### ADDITIONAL IMAGES

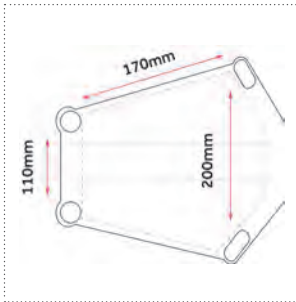

- Heavy duty coupling, built to withstand all the rigours of all industrial and commercial use
- Cast iron body has been designed for maximum strength and fits on top of or inside the A-frame
- Variant: coupling only
- Ball head: 50mm
- Maximum towing capacity: 2,700kg
- 71/320 approval: CD87/002
- 94/20 approval: e11\*94/20\*0106\*00

CODE	CAPACITY	MAX NOSE WEIGHT	LENGTH	HOLE DIAMETER	HOLE PATTERN	OE REF
G3051	1,600 - 2,700kg	100kg	700mm	14mm	SEE DIAGRAM	EH27MF

## BRADLEY HU12 3500KG HYDRATOW DELTA HITCH



### ADDITIONAL IMAGES

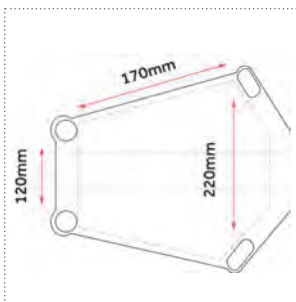

- Heavy duty coupling, built to withstand all the rigours of all industrial and commercial use
- Cast iron body has been designed for maximum strength and fits on top of or inside the A-frame
- Variant: coupling only
- Ball head: 50mm
- Maximum towing capacity: 3,500kg
- 71/320 approval: CD87/002
- 94/20 approval: e11\*94/20\*0106\*00

CODE	CAPACITY	MAX NOSE WEIGHT	LENGTH	HOLE DIAMETER	HOLE PATTERN	OE REF
G3042C	2,250 - 3,500kg	120kg	725mm	14mm	SEE DIAGRAM	H35MF

## BRADLEY HU3 COUPLING HEAD KIT



- Bradley HU3 50mm ball coupling head kit 266
- Supplied complete with bellows, ties, nuts and bolts
- Suitable for G3052 & G3051



CODE	CAPACITY	LENGTH	THREAD SIZE	OE REF
G13289	1,700 - 2,700kg	215mm	M12	KIT266

### ADDITIONAL IMAGES



## BRADLEY HU12 COUPLING HEAD KIT



- Bradley HU12 50mm ball coupling head kit 2030
- Supplied complete with bellows, ties, nuts and bolts
- Suitable for G3042C



CODE	CAPACITY	LENGTH	THREAD SIZE	OE REF
G13290	3,500kg	200mm	M14	KIT2030

### ADDITIONAL IMAGES



## BRADLEY PAD 3350 & HANDLE KIT



- Bradley replacement pad and handle
- Suitable for for HU3L, 3H, HU4 and HU5 up to 2700 kg, couplings
- Screws into side of coupling to secure jockey wheel assembly
- Used on older couplings and cast clamps
- Supplied complete with pad to protect jockey the wheel tube



CODE	SUITABILITY	DIMENSIONS	THREAD SIZE	OE REF
G12674	2,700kg hitch	110 x 110mm	1/2in	KIT3350

## BRADLEY PAD 3349 & HANDLE KIT



- Replacement pad and handle for HU12 3500kg coupling
- Screws into side of coupling to secure jockey wheel assembly
- Supplied complete with cast grip block
- Supplied complete with pad to protect jockey the wheel tube



CODE	SUITABILITY	DIMENSIONS	THREAD SIZE	OE REF
G13972	3,500kg hitch	120 x 110mm	5/8in	KIT3349

## BRADLEY TRIGGER SPRING



- Replacement trigger spring D101, D201, D5050, HU10 and all spring damped coupling heads



CODE	LENGTH	THICKNESS	OUTER DIAMETER
G3154	25mm	2mm	10mm

## GENFITT 1,700KG COUPLING DAMPER KIT

- Replacement coupling damper kit
- Suitable for HU3H, HU8H, EH17 and S18 Bradley braked couplings



CODE	TYPE	CAPACITY	LENGTH	OUTER DIAMETER	HOLE DIAMETER	OE REF
DK630824035	Eye x Thread	1,700kg	390mm	24mm	12mm	KIT3220

## BRADLEY 255 DAMPER KIT



- Replacement Bradley coupling damper kit 255
- Suitable for HU10, HU12, EH35 and HU14 Bradley braked couplings



CODE	TYPE	CAPACITY	LENGTH	OUTER DIAMETER	HOLE DIAMETER	OE REF
G12669	Eye x Thread	3,500kg	390mm	29mm	14mm	KIT255

## BRADLEY 259 DAMPER KIT



- Replacement Bradley coupling damper kit 259
- Suitable for HU6MK, HU8HE and S32 Bradley braked couplings



CODE	TYPE	CAPACITY	LENGTH	OUTER DIAMETER	HOLE DIAMETER	OE REF
G14120	Eye x Thread	2,600kg	385mm	24mm	12mm	KIT259



## BRADLEY 260 DAMPER KIT



- Replacement Bradley coupling damper kit 260
- Suitable for HU3HE, EH27, S26 and S32 Bradley braked couplings

CODE	TYPE	CAPACITY	LENGTH	OUTER DIAMETER	HOLE DIAMETER	OE REF
G12668	Eye x Eye	2,600kg	500mm	24mm	12mm	KIT260

## GENFITT 2,600KG COUPLING DAMPER KIT



- Replacement coupling damper kit 259
- Suitable for HU6MK, HU8HE and S32 Bradley braked couplings

CODE	TYPE	CAPACITY	LENGTH	OUTER DIAMETER	HOLE DIAMETER	OE REF
DK630824030	Eye x Thread	2,600kg	390mm	24mm	12mm	KIT259

## GENFITT 2,600KG (95+) COUPLING DAMPER KIT



- Replacement coupling damper kit 260
- Suitable for HU3HE, EH27, S26 and S32 Bradley braked couplings

CODE	TYPE	CAPACITY	LENGTH	OUTER DIAMETER	HOLE DIAMETER	OE REF
DK630024003	Eye x Eye	2,600kg	390mm	24mm	12mm	KIT260

## BRADLEY 3220 DAMPER KIT



- Replacement Bradley coupling damper kit 3220
- Suitable for HU3H, HU8H, EH17 and S18 Bradley braked couplings

CODE	TYPE	CAPACITY	LENGTH	OUTER DIAMETER	HOLE DIAMETER	OE REF
G12667	Eye x Thread	1,700kg	385mm	24mm	12mm	KIT3220

## GENFITT 3,500KG COUPLING DAMPER KIT



- Replacement coupling damper kit 255
- Suitable for HU10, HU12, EH35 and HU14 Bradley braked couplings

CODE	TYPE	CAPACITY	LENGTH	OUTER DIAMETER	HOLE DIAMETER	OE REF
DK630028014	Eye x Thread	3,500kg	390mm	28mm	14mm	KIT255



## BRADLEY 107 BELLOWS SERVICE KIT



- Replacement coupling bellows
- Suitable for Bradley HU3, HU4, HU5, HU6, HU8L and HU8H couplings
- Tube diameter: 48mm
- Complete kit includes gaiter and nuts

CODE	SUITABILITY	LENGTH	THREAD SIZE	OE REF
G3043A	1,700 - 2,600kg	130mm	M12	KIT107

TRAILER

## BRADLEY 2039 BELLOWS SERVICE KIT



- Replacement coupling bellows
- Suitable for Bradley HU8, HE12, HE14 Mk4 head couplings
- Tube diameter: 60mm
- Complete kit includes gaiter and nuts

CODE	SUITABILITY	LENGTH	THREAD SIZE	OE REF
G3043B	3,500kg	70mm	M14	KIT2039

## BRADLEY LOCK-IT



- Bradley coupling head lock-kit insert
- Fits all Bradley heads with insert facility
- Supplied complete with 2-4 keys
- All lock-kit's are totally unique

CODE	TYPE	OE REF
G3027A	Complete set	LOCKIT1-2

8

## BRADLEY BREAKAWAY CABLE KIT



- Replacement breakaway cable kit
- For use with Bradley braked couplings

CODE	TYPE	LENGTH	OUTER DIAMETER	MATERIAL	OE REF
G3043C	Ring	950mm	5mm	Coated Wire Rope	KIT129
G18561	Ring	990mm	5mm	Coated Wire Rope	-
G19315	Ring	1,000mm	5mm	Red PVC	-
G19316	Ring	1,000mm	5mm	High Viz PVC	-

## 1,400KG PRESSED STEEL COUPLING HEAD

**KNOTT**

- Knott-Avonride unbraked pressed steel coupling
- Variant: to fit 50mm box section drawtube
- Maximum towing capacity: 1,400kg

CODE	CAPACITY	LENGTH	HOLE DIAMETER	HOLE PATTERN	MATERIAL	OE REF
G13546	1,400kg	265mm	12mm	90mm	Pressed Steel	ZSK1300H

## 2,000KG PRESSED STEEL COUPLING HEAD

**KNOTT**

- Knott-Avonride unbraked pressed steel coupling
- Variant: to fit 50mm box section drawtube
- Soft-grip handle
- Maximum towing capacity: 2,000kg

CODE	CAPACITY	LENGTH	THREAD SIZE	OE REF
G12478	2,000kg	210mm	M12	SB046

## KNOTT BQ-27 750KG CAST COUPLING HEAD

**KNOTT**



- Knott BQ-27 unbraked cast coupling head
- Variant: 2 bolt
- Ball head: 50mm
- Supplied with integral insert lock and 2 keys
- Maximum towing capacity: 750kg (2,700kg off road only)

CODE	CAPACITY	MAX NOSE WEIGHT	LENGTH	HOLE DIAMETER	HOLE PATTERN	OE REF
G18089	750kg	150kg	255mm	14mm	80mm	6E0286.001

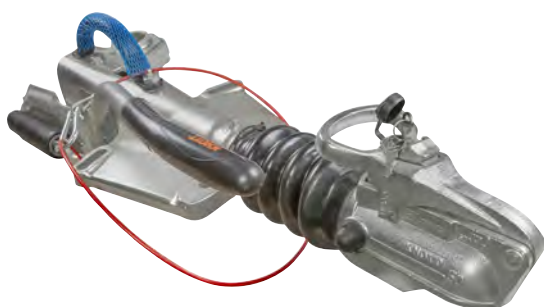
**AVONRIDE 2,000KG HITCH**

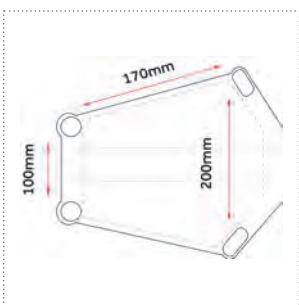

**ADDITIONAL IMAGES**



- Knott-Avonride cast delta style coupling assembly
- Cast iron body design with frame suitable for fitting on top or inside trailer drawbar A-frame
- Variant: coupling only
- Ball head: 50mm
- Suitable for 48mm jockey wheels
- Supplied with hitch lock and 2 keys
- Maximum towing capacity: 2,000kg
- 71/320 approval: CD87/002
- 94/20 approval: e11\*94/20\*0106\*00

CODE	CAPACITY	MAX NOSE WEIGHT	LENGTH	HOLE PATTERN
G12103	1,300 - 2,000kg	100kg	695mm	SEE DIAGRAM

**AVONRIDE 2,700KG HITCH**



**ADDITIONAL IMAGES**

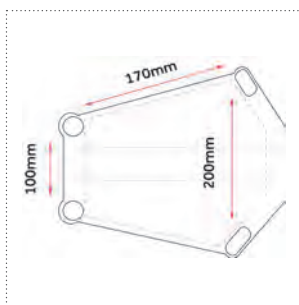

- Knott-Avonride cast delta style coupling assembly
- Cast iron body design with frame suitable for fitting on top or inside trailer drawbar A-frame
- Variant: coupling only
- Ball head: 50mm
- Suitable for 48mm jockey wheels
- Supplied with hitch lock and 2 keys
- Maximum towing capacity: 2,700kg
- 71/320 approval: CD87/002
- 94/20 approval: e11\*94/20\*0106\*00

CODE	CAPACITY	MAX NOSE WEIGHT	LENGTH	HOLE PATTERN
G12104	1,600 - 2,700kg	100kg	695mm	SEE DIAGRAM

## AVONRIDE 3,500KG HITCH

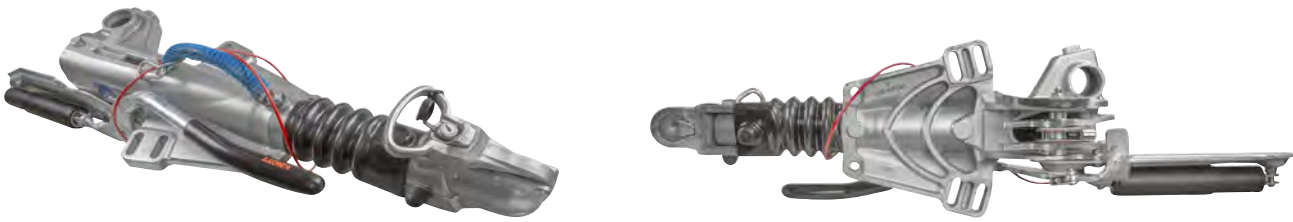

TRAILER

### ADDITIONAL IMAGES

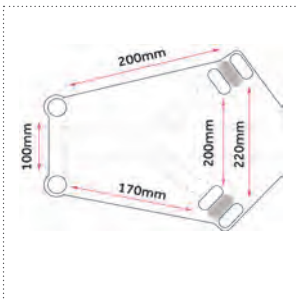

- Knott-Avonride cast delta style coupling assembly
- Cast iron body design with frame suitable for fitting on top or inside trailer drawbar A-frame
- Variant: coupling only
- Ball head: 50mm
- Suitable for 48mm jockey wheels
- Supplied with hitch lock and 2 keys
- Maximum towing capacity: 3,500kg
- 71/320 approval: CD87/002
- 94/20 approval: e11\*94/20\*0106\*00

CODE	CAPACITY	MAX NOSE WEIGHT	LENGTH	HOLE PATTERN
G12105	2,250 - 3,500kg	120kg	740mm	SEE DIAGRAM

## 2,700KG CAST COUPLING HEAD



11



- Replacement Knott-Avonride braked / unbraked coupling head
- Ball head: 50mm
- Supplied with hitch lock and 2 keys
- Maximum towing capacity: 2,700kg
- Suitable head for braked assemblies G12103 and G12104

CODE	CAPACITY	LENGTH	THREAD SIZE	OE REF
G12479	2,700kg	190mm	M12	SB047

### ADDITIONAL IMAGES



### 3,500KG CAST COUPLING HEAD



- Replacement Knott-Avonride braked / unbraked coupling head
- Ball head: 50mm
- Supplied with hitch lock and 2 keys
- Maximum towing capacity: 3,500kg
- Suitable head for braked assembly G12105

CODE	CAPACITY	LENGTH	THREAD SIZE	OE REF
G12480	3,500kg	205mm	M14	SB048

#### ADDITIONAL IMAGES



### COUPLING HEAD LOCK KIT



- Avonride spare lock-kit for coupling head
- Fits Avonride coupling heads
- Supplied with 2 keys

CODE	TYPE	OE REF
G12467	Complete Set	SB035

### 1,300KG COUPLING DAMPER



- Replacement coupling damper to fit Knott-Avonride 1,300 kg braked couplings
- Extended length, centre of eye to start of thread: 540mm

CODE	TYPE	CAPACITY	LENGTH	OUTER DIAMETER	HOLE DIAMETER
G12471	Eye x Thread	750 - 1,300kg	530mm	28mm	12mm

### GENFITT 2,000KG COUPLING DAMPER



- Replacement coupling damper to fit Knott-Avonride 2,000kg braked couplings
- Extended length, centre of eye to start of thread: 540mm

CODE	TYPE	CAPACITY	LENGTH	OUTER DIAMETER	HOLE DIAMETER	OE REF
DK630028011	Eye x Thread	1,300 - 2,000kg	540mm	28mm	12mm	SB040

## 2,700KG COUPLING DAMPER



- Replacement coupling damper to fit Knott-Avonride 2,700kg braked couplings
- Extended length, centre of eye to start of thread: 540mm

CODE	TYPE	CAPACITY	LENGTH	OUTER DIAMETER	HOLE DIAMETER	OE REF
G12473	Eye x Thread	1,400 - 2,700kg	540mm	28mm	12mm	SB041

## GENFITT 2,700KG COUPLING DAMPER



- Replacement coupling damper to fit Knott-Avonride 2,700 kg braked couplings
- Extended length, centre of eye to start of thread: 530mm

CODE	TYPE	CAPACITY	LENGTH	OUTER DIAMETER	HOLE DIAMETER	OE REF
DK630028012	Eye x Thread	1,400 - 2,700kg	530mm	28mm	12mm	SB041

## 3,500KG COUPLING DAMPER



- Replacement coupling damper to fit Knott-Avonride 3,500kg braked couplings
- Extended length, centre of eye to start of thread: 590mm

CODE	TYPE	CAPACITY	LENGTH	OUTER DIAMETER	HOLE DIAMETER	OE REF
G12474	Eye x Thread	2,700 - 3,500kg	590mm	28mm	14mm	SB042

## GENFITT 3,500KG COUPLING DAMPER



- Replacement coupling damper to fit Knott-Avonride 3,500 kg braked couplings
- Extended length, centre of eye to start of thread: 590mm

CODE	TYPE	CAPACITY	LENGTH	OUTER DIAMETER	HOLE DIAMETER	OE REF
DK630028013	Eye x Thread	2,700 - 3,500kg	590mm	28mm	14mm	SB042

## AVONRIDE RED HITCH BELLOWS



- Replacement Knott-Avonride coupling bellows
- Suitable for coupling up to 2,700kg capacity

CODE	CAPACITY	LENGTH	THREAD SIZE	OE REF
G12476	2,700kg	155mm	M12	SB044

**AVONRIDE BLACK HITCH BELLOWS**

TRAILER



- Replacement Knott-Avonride coupling bellows
- Suitable for coupling up to 2,700kg capacity

CODE	CAPACITY	LENGTH	THREAD SIZE	OE REF
G12475	2,700kg	150mm	M12	SB043

**AVONRIDE/KNOTT 3,500KG COUPLING BELLOWS**



- Replacement Knott-Avonride coupling bellows
- Suitable for coupling up to 3,500kg capacity

CODE	CAPACITY	LENGTH	THREAD SIZE	OE REF
G16254	3,500kg	185mm	M12	B25720-501083

**CLAMP HANDLE**

14



- Replacement locking handle and pad for jockey wheel clamp
- Model SB036

CODE	DIMENSIONS	THREAD SIZE	OE REF
G12468	100 x 130mm	5/8in (16mm)	SB036

**AVONRIDE SAFETY CABLE**



- Replacement breakaway cable kit
- For use with Knott-Avonride braked couplings

CODE	TYPE	LENGTH	OUTER DIAMETER	MATERIAL	OE REF
G12469	Clevis	1,050mm	5mm	Coated Wire Rope	SB037
G18560	Clevis	950mm	5mm	Coated Wire Rope	-



## CRANKED HITCH EYE



- Cranked / stepped weld-on hitch eyes
- Suitable to be welded to drawbars of agricultural trailers
- Material: forged steel EN3, EN16
- Different lengths available depending on application

CODE	TYPE	DIMENSIONS	EYE	MATERIAL
G2949	Weld-on Cranked	300 x 90 x 30mm	50mm	Forged Steel EN3
G2950	Weld-on Cranked	400 x 90 x 30mm	50mm	Forged Steel EN3
G3144	Weld-on Cranked	300 x 90 x 30mm	50mm	Forged Steel EN16
G3146	Weld-on Cranked	400 x 90 x 30mm	50mm	Forged Steel EN16

## SHORT FLAT HITCH EYE



- Flat weld-on hitch eye
- Suitable to be welded to drawbars on agricultural trailers
- Material: forged steel EN3A

CODE	TYPE	DIMENSIONS	EYE	MATERIAL
G17791	Weld-on Flat	125 x 90 x 30mm	50mm	Forged Steel EN3A

## STANDARD FLAT HITCH EYE



- Flat weld-on hitch eyes
- Suitable to be welded to drawbars on agricultural trailers
- Material: forged steel EN3A, EN16
- Different length, size and material available depending on application

CODE	TYPE	DIMENSIONS	EYE	MATERIAL
G2947	Weld-on Flat	300 x 90 x 30mm	50mm	Forged Steel EN3A
G2948	Weld-on Flat	400 x 90 x 30mm	50mm	Forged Steel EN3A
G3143	Weld-on Flat	300 x 90 x 30mm	50mm	Forged Steel EN16
G3145	Weld-on Flat	400 x 90 x 30mm	50mm	Forged Steel EN16

## 14 TON FLAT HITCH EYE



- Flat weld on hitch eye
- Suitable to be welded to drawbars on agricultural trailers
- Material: forged steel EN8
- Vertical load: 3,000kg Horizontal load: 14,000kg
- Produced in accordance with ISO 5692

CODE	TYPE	CAPACITY	DIMENSIONS	EYE	MATERIAL
G2951A	Weld-on Flat	14 Ton (14,000kg)	300 x 90 x 30mm	50mm	Forged Steel EN8

## 25 TON FLAT HITCH EYE



- Flat weld-on hitch eye
- Suitable to be welded to drawbars on agricultural trailers
- Vertical load: 3,000kg Horizontal load: 25,000kg
- Produced in accordance with ISO 5692

CODE	TYPE	CAPACITY	DIMENSIONS	EYE	MATERIAL
G2951C	Weld-on Flat	25 Ton (25,000kg)	300 x 90 x 30mm	50mm	Forged Steel EN16

## 32 TON FLAT HITCH EYE



- Flat weld-on hitch eye
- Suitable to be welded to drawbars of agricultural trailers
- Material: forged steel
- Vertical load: 3,500kg Horizontal load: 32,000kg
- Produced in accordance with ISO 5692

CODE	TYPE	CAPACITY	DIMENSIONS	EYE	MATERIAL
G15623	Weld-on Flat	32 Ton (32,000kg)	335 x 45 x 40mm	50mm	Forged Steel

## SWIVEL HITCH EYE



- Swivel weld-on hitch eyes
- Suitable to be welded to drawbars of agricultural trailers
- Suitable for trailers and interchangeable equipment working with heavy loads and in uneven conditions to help prevent potential overturns
- Vertical load: 3,500kg

CODE	TYPE	CAPACITY	LENGTH	OUTER DIAMETER	EYE	MATERIAL
G12746	Weld-on Swivel	25 Ton (25,000kg)	385mm	76mm	76mm	Forged Steel
G12747	Weld-on Swivel	20 Ton (20,000kg)	385mm	82mm	52mm	Forged Steel

## HITCH EYE REDUCER BUSHION



- Suitable for weld-on hitch eyes to reduce hole size from 50mm to 30mm
- Finish: zinc plated

CODE	OUTER DIAMETER	INNER DIAMETER	MATERIAL
G2951B	50mm	30mm	Forged Steel

## FLANGE HITCH EYE RIGID



- Flange type bolt-on 50mm ring hitch eye
- Suitable to be bolted onto heavy duty agricultural trailers
- Vertical load: 3,000kg Horizontal load: 30,000kg
- Fitment: vertical 8 hole
- Finish: black primer



CODE	TYPE	CAPACITY	LENGTH	HOLE PATTERN	EYE	THREAD SIZE	OE REF
G18586	Bolt-on Rigid	30 Ton (30,000kg)	252mm	145 x 145mm	50mm	M20	00.654.41.0-A02

### ADDITIONAL IMAGES



## FLANGE HITCH EYE SWIVEL



- Flange type bolt-on 50mm ring hitch eye
- Suitable to be bolted onto heavy duty agricultural trailers
- Vertical load: 3,000kg Horizontal load: 30,000kg
- Fitment: vertical 8 hole
- Finish: black primer



CODE	TYPE	CAPACITY	LENGTH	HOLE PATTERN	EYE	THREAD SIZE	OE REF
G18588	Bolt-on Swivel	30 Ton (30,000kg)	295mm	145 x 145mm	50mm	M20	00.654.43.0-A02

### ADDITIONAL IMAGES



## FLANGE SPOON COUPLING



- Flange type bolt-on K80 spoon towing hitch
- Suitable to be bolted onto heavy duty agricultural trailers
- Vertical load: 4,000kg Horizontal load: 31,500kg
- Fitment: vertical 8 hole
- Finish: black primer

CODE	TYPE	CAPACITY	LENGTH	HOLE PATTERN	EYE	THREAD SIZE	OE REF
G18587	Bolt-on Spoon	31.5 Ton (31,500kg)	252mm	145 x 145mm	50mm	M20	00.650.90.1-A02

### ADDITIONAL IMAGES



## FLANGE TYPE FIXING PLATES



- Weld-on fixing plate for flange type bolt on hitch eyes
- Finish: self colour

CODE	TYPE	FITMENT	DIMENSIONS	HOLE DIAMETER	HOLE PATTERN	OE REF
G18589	1 position	Vertical 8 hole	200 x 200 x 40mm	20mm	145 x 145mm	00.645.01.0
G18590	4 Positions	Vertical 18 hole	422 x 200 x 40mm	20mm	145 x 145mm	00.645.09.0

### ADDITIONAL IMAGES

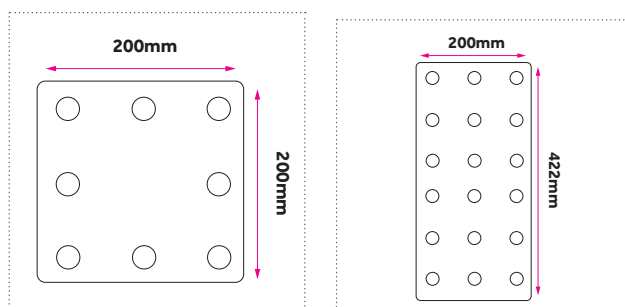

## FLANGE TYPE FIXING SCREWS



- M20 Fixing bolts and washers
- Thread into pre-tapped weld on fixing plates
- Suitable for 8 hole and 18 hole fixing plate
- Pack of 8
- Grade: 10.9

CODE	TYPE	LENGTH	THREAD SIZE	MATERIAL
G18591	Hexagonal Head Set	80mm	M20	Tensile Grade - 10.9

# TOWING HITCHES

## BRADLEY E40TC 3.5 TON TOWING JAW



- Dual Bradley tow jaw, ball and pin combined in one
- Model: E40TC
- Variant: 2 bolt
- Ball head: 50mm
- Complete with 25mm pin
- Use grade 8.8 or higher M16 bolts and nuts with lock washer
- Tighten to 240Nm
- Finish: zinc plated

DIAGRAM

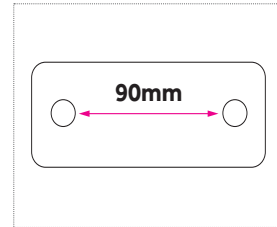

CODE	CAPACITY	DIMENSIONS	HOLE CENTRE	HOLE DIAMETER	D VALUE	S VALUE	BOLT SIZE	OE REF
G16399	3.5 Ton (3,500kg)	190 x 140 x 90mm	90mm	17mm	17kN	200kg	M16	V352L

## BRADLEY E100T 3.5 TON TOWING JAW

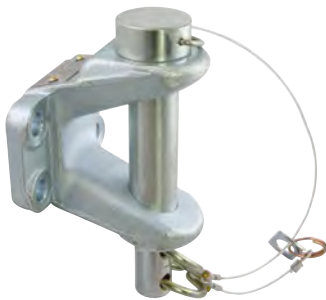

- Model: E100T
- Variant: 4 bolt
- Complete with 32mm pin
- Use grade 8.8 or higher M12 bolts and nuts with lock washer
- Tighten to 240Nm
- Type approved
- Finish: zinc plated

DIAGRAM

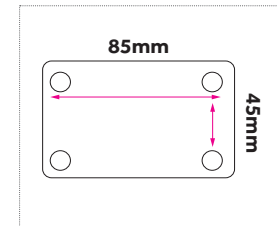

CODE	CAPACITY	DIMENSIONS	HOLE PATTERN	HOLE DIAMETER	D VALUE	S VALUE	BOLT SIZE	OE REF
G16400	3.5 Ton (3,500kg)	190 x 110 x 100mm	85 x 45mm	13mm	30.95kN	350kg	M12	V501L

## BRADLEY E100TC 3.5 TON TOWING JAW



- Dual Bradley tow jaw, ball and pin combined in one
- Model: E100TC
- Variant: 4 bolt
- Ball head: 50mm
- Complete with 32mm pin
- Use grade 8.8 or higher M16 bolts and nuts with lock washer
- Tighten to 240Nm
- Type approved
- Finish: zinc plated

DIAGRAM

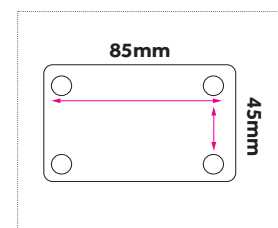

CODE	CAPACITY	DIMENSIONS	HOLE PATTERN	HOLE DIAMETER	D VALUE	S VALUE	BOLT SIZE	OE REF
G16401	3.5 Ton (3,500kg)	220 x 110 x 115mm	85 x 45mm	17mm	30.95kN	350kg	M16	V502L

## DIXON BATE DB202014 3.5 TON DUAL TOWING BALL



- Dixon bate dual tow jaw, fixed ball with loose pin separate
- Model: DB202014
- Variant: 2 bolt
- Ball head: 50mm
- Complete with 25mm pin
- Use grade 8.8 or higher M16 bolts and nuts with lock washer
- Tighten to 240Nm
- Type approved

### DIAGRAM

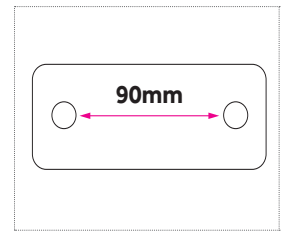

CODE	CAPACITY	DIMENSIONS	HOLE CENTRE	HOLE DIAMETER	D VALUE	S VALUE	BOLT SIZE	OE REF
G15009	3.5 Ton (3,500kg)	190 x 135 x 135mm	90mm	17mm	17.2kN	250kg	M16	

## DIXON BATE DUAL TOWING BALL PIN



- Replacement tow pin for dual tow jaw
- Finish: zinc plated

CODE	LENGTH	OUTER DIAMETER	SUITABILITY	OE REF
G17823	135mm	25mm	G15009	DB68121

## DIXON BATE DB201691 3.5 TON DUAL TOWING BALL



- Dixon bate dual tow jaw, fixed ball with loose pin separate
- Model: DB201691
- Variant: 4 bolt
- Ball head: 50mm
- Complete with 32mm pin
- Use grade 8.8 or higher M12 bolts and nuts with lock washer
- Tighten to 240Nm
- Type approved
- Finish: zinc plated

### DIAGRAM

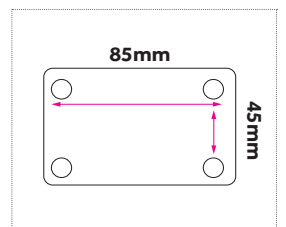

CODE	CAPACITY	DIMENSIONS	HOLE PATTERN	HOLE DIAMETER	D VALUE	S VALUE	BOLT SIZE	OE REF
G17783	3.5 Ton (3,500kg)	210 x 120 x 130mm	85 x 45mm	14mm	30.95kN	350kg	M12	DB201691

## DUAL TOWING BALL & PIN HITCH



- Dual tow jaw, fixed ball with loose pin separate
- Variant: 2 bolt
- Ball head: 50mm
- Complete with 25mm pin
- Use grade 8.8 or higher M16 bolts and nuts with lock washer
- Tighten to 240Nm
- Approved to Reg 55
- Approval number: E11 55R 018119

### DIAGRAM

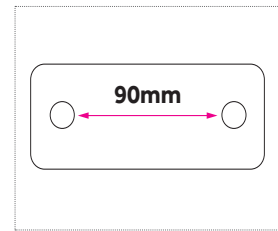

CODE	CAPACITY	DIMENSIONS	HOLE CENTRE	HOLE DIAMETER	D VALUE	S VALUE	BOLT SIZE	OE REF
G15008	3.5 Ton (3,500kg)	90 x 130 x 120mm	90mm	17mm	20kN	350kg	M16	MP82

## HITCH PIN WITH ROPE & CLIP



- Replacement tow pin for standard dual tow jaw
- Finish: zinc plated

CODE	LENGTH	OUTER DIAMETER	SUITABILITY
G16617	135mm	25mm (1in)	G15008

## FLANGE 3 TON (3000KG) TOWBALL



- Flange towball hitch
- Variant: 2 bolt
- Ball head: 50mm
- Use grade 8.8 or higher M16 bolts and nuts with lock washer
- Tighten to 240Nm
- Finish: yellow passivated
- E.U. approved

CODE	CAPACITY	DIMENSIONS	HOLE CENTRE	HOLE DIAMETER	D VALUE	S VALUE
G3050	3 Ton (3,000kg)	110 x 130 x 80mm	90mm	17mm	17.2kN	270kg

## HEAVY DUTY 2 TON (2,000 KG) BLACK DOUBLE DUTY HITCH



- Dual tow jaw, fixed ball with pin through ball
- Variant: 2 bolt
- Ball head: 50mm
- Complete with 19mm pin through ball centre
- Auto-locking pin
- Use grade 8.8 or higher M16 bolts and nuts with lock washer
- Tighten to 240Nm
- Off road use only
- Not recommended for towing heavy vehicles

DIAGRAM

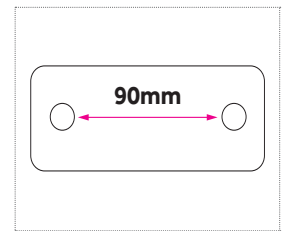

CODE	CAPACITY	DIMENSIONS	HOLE CENTRE	HOLE DIAMETER
G3050B	2 Ton (2,000kg)	150 x 135 x 90mm	90mm	17mm

## 1.5 TON (1,500 KG) BLUE DOUBLE DUTY HITCH



- Dual tow jaw, fixed ball with pin through ball
- Variant: 2 bolt
- Ball head: 50mm
- Complete with 22mm pin
- Use grade 8.8 or higher M16 bolts and nuts with lock washer
- Tighten to 240Nm
- Must only be used with supplied pin in place
- Off road use only
- Not recommended for towing heavy vehicles

DIAGRAM

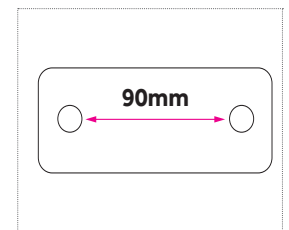

CODE	CAPACITY	DIMENSIONS	HOLE CENTRE	HOLE DIAMETER
G3047	1.5 Ton (1,500kg)	135 x 140 x 90mm	90mm	17mm

## 1.5 TON (1,500 KG) BLUE DOUBLE DUTY INDEPENDENT HITCH



- Dual tow jaw, fixed ball with loose pin
- Variant: 2 bolt
- Ball head: 50mm
- Complete with 22mm pin
- Use grade 8.8 or higher M16 bolts and nuts with lock washer
- Tighten to 240Nm
- Off road use only
- Not recommended for towing heavy vehicles

DIAGRAM

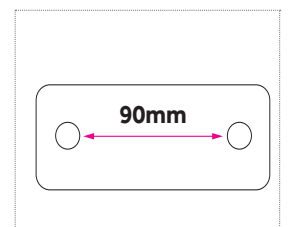

CODE	CAPACITY	DIMENSIONS	HOLE CENTRE	HOLE DIAMETER
G3049	1.5 Ton (1,500kg)	145 x 140 x 150mm	90mm	17mm



## SHORT SERIES TOWBALL



- Short series threaded towball hitch
- Ball head: 50mm
- Supplied complete with nut and washer
- Not recommended for heavy vehicles
- Finish: zinc plated

CODE	CAPACITY	LENGTH	OUTER DIAMETER	THREAD SIZE
G3157	500kg	75mm	19mm	3/4in
G3044	750kg	75mm	22mm	7/8in
G3158	1,000kg	75mm	25.4mm	1in

## LONG SERIES TOWBALL



- Long series threaded towball
- Ball head: 50mm
- Supplied complete with safety chain pin and locking nuts
- Not recommended for heavy vehicles
- Finish: zinc plated

CODE	CAPACITY	LENGTH	OUTER DIAMETER	THREAD SIZE
G3045	1,250kg	190mm	22mm	7/8in
G3046	2,000kg	190mm	25.4mm	1in
G16993	3,000kg	190mm	32mm	1.1/4in

## PINBALL NUT



- Replacement nut for long series towball hitch
- Thread type: rough

CODE	OUTER DIAMETER	THREAD SIZE	FINISH	SUITABILITY
G17445	37mm	1in	Zinc Plated	G3046

## TOWBALL SPACER BLOCK

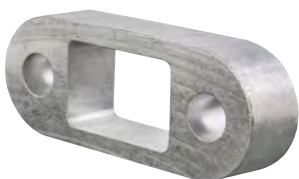

- Towball spacer block
- Bolt size: M16

CODE	SIZE	DIMENSIONS	HOLE PATTERN	HOLE DIAMETER	MATERIAL
G3050A	25mm (1in)	130 x 25mm	90mm	17mm	Extruded Aluminium

## STAINLESS STEEL BUMPER PROTECTOR



- Rear bumper protector
- Suitable to be attached behind towball on vehicle

CODE	DIMENSIONS	HOLE PATTERN	MATERIAL
G17212	180 x 150mm	90mm	Stainless Steel

### ADDITIONAL IMAGES



## DOUBLE PIN SLIDER PLATE COUPLING 100MM



- Dixon Bate adjustable height towball plate slider coupling
- Two pin slider plate couple
- Suitable for flange type towballs to set height at different levels depending on application
- Adjustable in 50mm increments
- 4 bolt fixing to vehicle
- 2 or 4 bolt coupling compatible
- 19mm diameter steel securing pin (x 2)
- Finish: black
- **HITCH NOT INCLUDED**

CODE	DIMENSIONS	HOLE PATTERN	HOLE DIAMETER	D VALUE	S VALUE	RANGE	OE REF
G19518	242 x 146mm	90 x 45mm	17mm	23.41kN	350kg	100mm	185010915

### ADDITIONAL IMAGES





## DOUBLE PIN SLIDER PLATE COUPLING 150MM



- Dixon Bate adjustable height towball plate slider coupling
- Variant: 2 pin slider plate couple
- Suitable for flange type towballs to set height at different levels depending on application
- Adjustable in 50mm increments
- 4 bolt fixing to vehicle
- 2 or 4 bolt coupling compatible
- 19mm diameter steel securing pin (x2)
- Finish: black
- **HITCH NOT INCLUDED**

CODE	DIMENSIONS	HOLE PATTERN	HOLE DIAMETER	D VALUE	S VALUE	RANGE	OE REF
G19516	292 x 146mm	90 x 45mm	17mm	23.41kN	350kg	150mm	185011015

### ADDITIONAL IMAGES

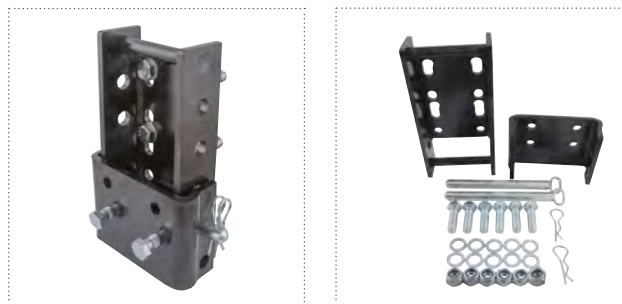

## COP TRAILER LOCK



- Anti-theft expandable lock for ball type trailer hitches
- Suitable for locking of all types of 50mm ball couplings

CODE	TYPE
G3029A	Complete Kit

## TRAILER SAFETY CHAIN



- Trailer breakaway chain
- Suitable for non-braked trailers
- Designed to be fitted to the trailer drawbar and using the large loop attach to vehicle tow ball during use
- Suitable for light duty general purpose trailers
- Finish: Zinc plated

CODE	SIZE	LENGTH
G3159	10mm Link	670mm

## TRAILER JOCKEY WHEELS

### AUTO FOLDING JOCKEY WHEEL



- Heavy duty auto folding jockey wheel
- Supplied with integral mounting plate (100 x 130mm) for easy fitting onto the trailer
- Wheel: solid rubber tyre and steel rim
- Ball-race handle bearing ensures smooth and easy handle rotation
- Wheel is raised automatically during retraction and locks in the raised position. It is released automatically when wound down again with the handle
- Grease nipple bearing lubrication inlet
- Constructed for heavy duty trailer applications
- Suitable for car transporter, horse box, livestock, plant and twin axle trailers

CODE	MAX NOSE WEIGHT	LENGTH	WIDTH	TUBE DIAMETER	WHEEL/RIM DIAMETER	OE REF
G16988	300kg	460mm	130mm	60mm	200 x 50mm	977

### FC242 JOCKEY WHEEL COMPLETE



- Sliding jockey wheel
- Supplied with mounting bracket
- Wheel: solid wheel on steel centre
- Suitable for domestic and commercial use

CODE	MAX NOSE WEIGHT	LENGTH	WIDTH	TUBE DIAMETER	WHEEL/RIM DIAMETER	OE REF
G3062	100kg	370mm	130mm	48mm	200 x 50mm	FC242

### TJ11 JOCKEY WHEEL



- Light duty sliding jockey wheel
- Supplied without bracket
- Wheel: solid rubber tyre on steel centre
- Suitable for use on small domestic trailers

CODE	MAX NOSE WEIGHT	LENGTH	TUBE DIAMETER	WHEEL/RIM DIAMETER	OE REF
G3057	50kg	360mm	35mm	155 x 40mm	TJ11

## TJ12 JOCKEY WHEEL



- Medium duty sliding jockey wheel
- Supplied without bracket
- Wheel: solid wheel on steel centre
- Suitable for domestic and commercial use

CODE	MAX NOSE WEIGHT	LENGTH	TUBE DIAMETER	WHEEL/RIM DIAMETER	OE REF
G3058	200kg	440mm	42mm	170 x 45mm	TJ12

## TJ12 JOCKEY WHEEL WITH BRACKET



- Medium duty sliding jockey wheel
- Supplied with mounting bracket
- Wheel: solid rubber tyre on steel centre
- Suitable for domestic and commercial use

CODE	MAX NOSE WEIGHT	LENGTH	WIDTH	TUBE DIAMETER	WHEEL/RIM DIAMETER	OE REF
G3058B	200kg	435mm	130mm	42mm	170 x 45mm	TJ12

## TJ15 JOCKEY WHEEL



- Medium duty jockey wheel
- Supplied without bracket
- Wheel: solid rubber wheel on steel centre
- Suitable for domestic and commercial use

CODE	MAX NOSE WEIGHT	LENGTH	TUBE DIAMETER	WHEEL/RIM DIAMETER	OE REF
G13273	100kg	370mm	48mm	200 x 50mm	TJ15

## JOCKEY WHEEL COMPLETE WITH PNEUMATIC WHEEL



- Medium duty jockey wheel with pneumatic wheel
- Supplied with mounting bracket
- Wheel: pneumatic wheel for ease of moveability
- Replacement wheel: G3200A

CODE	MAX NOSE WEIGHT	LENGTH	WIDTH	TUBE DIAMETER	WHEEL/RIM DIAMETER
G17514	200kg	360mm	320mm	48mm	260 x 85mm

## TJ15S JOCKEY WHEEL



- Heavy duty ribbed sliding jockey wheel
- Supplied without bracket
- Wheel: solid wheel on steel centre
- Suitable for domestic and commercial use

CODE	MAX NOSE WEIGHT	LENGTH	TUBE DIAMETER	WHEEL/RIM DIAMETER	OE REF
G3059	500kg	500mm	48mm	200 x 55mm	TJ15S

### ADDITIONAL IMAGES

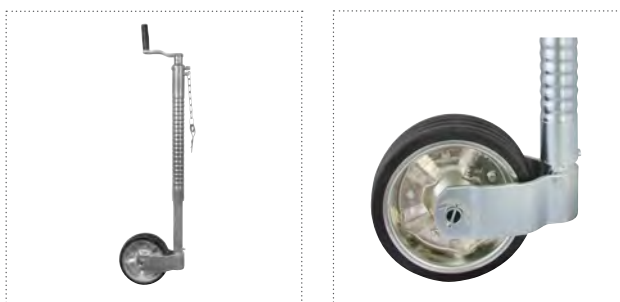

## JOCKEY WHEEL COMPLETE WITH FLANGE BRACKET

28



- Heavy duty side winding jockey wheel
- Supplied with 4 bolt flange side plate mounting bracket
- Wheel: solid plastic
- Constructed for heavy duty trailer applications
- Suitable for car transporter, horse box, livestock, plant and twin axle trailers

CODE	MAX NOSE WEIGHT	LENGTH	WIDTH	TUBE DIAMETER	WHEEL/RIM DIAMETER
G19133	450kg	390mm	145mm	35mm	155 x 40mm

### ADDITIONAL IMAGES

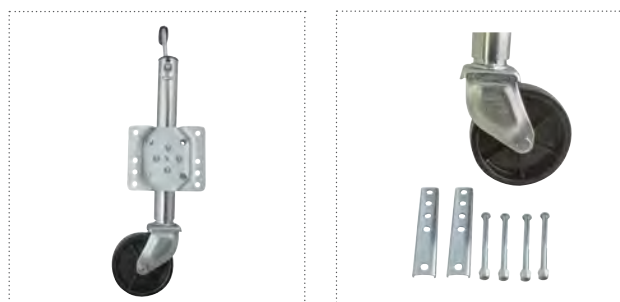

## FC242 BRACKET - 48MM



- Replacement jockey wheel clamp bracket
- Suitable for 48mm diameter jockey wheels, legs and support poles
- Allows the removal of the jockey wheel or leg without removing clamp
- Heavy duty applications

CODE	WIDTH	HOLE CENTRE	SUITABILITY
G3063	130mm	105mm	G3062, G3059

## TJ11 JOCKEY WHEEL BRACKET - 35MM



- Replacement jockey wheel clamp bracket
- Suitable for 35mm diameter jockey wheels, legs and support poles
- Allows the removal of the jockey wheel or leg without removing clamp
- Light duty applications

CODE	WIDTH	HOLE CENTRE	SUITABILITY
G3057A	130mm	80mm	G3057

## TJ12 JOCKEY WHEEL BRACKET - 42MM



- Replacement jockey wheel clamp bracket
- Suitable for 42mm diameter jockey wheels, legs and support poles
- Allows the removal of the jockey wheel or leg without removing clamp
- Light duty applications

CODE	WIDTH	HOLE CENTRE	SUITABILITY
G3058A	130mm	80mm	G3058

## TJ15S JOCKEY WHEEL BRACKET - 48MM



- Replacement ribbed jockey wheel cast clamp bracket
- Has internal ribbing suitable for heavy duty 48mm jockey wheels and legs with serrated shafts
- Also suitable for plain shafts
- Heavy duty applications

CODE	WIDTH	HOLE CENTRE	SUITABILITY
G3060	180mm	80mm	G3059

## WHEEL ASSEMBLY FOR FC242 JOCKEY WHEEL



- Replacement wheel for jockey wheel
- Steel wheel with solid rubber tyre
- Suitable for FC242

CODE	WHEEL/RIM DIAMETER	SUITABILITY	OE REF
G3064	200 x 40 x 20mm	G3062	FC242

## WHEEL ASSEMBLY FOR TJ11 JOCKEY WHEEL



- Replacement wheel for jockey wheel
- Steel wheel with solid rubber tyre
- Suitable for TJ11

CODE	WHEEL/RIM DIAMETER	SUITABILITY	OE REF
G3065	180 x 50 x 22mm	G3057	TJ11

## WHEEL ASSEMBLY FOR TJ12 JOCKEY WHEEL



- Replacement wheel for jockey wheel
- Steel wheel with solid rubber tyre
- Suitable for TJ12

CODE	WHEEL/RIM DIAMETER	SUITABILITY	OE REF
G13513	175 x 45 x 20mm	G3058B	TJ12

## WHEEL ASSEMBLY FOR TJ15S JOCKEY WHEEL



- Replacement wheel for jockey wheel
- Steel wheel with solid rubber tyre
- Suitable for TJ15S

CODE	WHEEL/RIM DIAMETER	SUITABILITY	OE REF
G16184	200 x 55 x 20mm	G3059	TJ15S



# TRAILER BOX JACKS

## TOP WINDING BOX JACK



- Top winding square box jack
- Supplied with round flat base plate
- Suitable to be welded or bolted on to trailer drawbar
- Not for lifting

CODE	MAX NOSE WEIGHT	SIZE	CLOSED HEIGHT	STROKE	OVERALL HEIGHT	OE REF
G3070	600kg	60 x 60mm	460mm	255mm	590mm	P545
G15004	800kg	60 x 60mm	500mm	330mm	-	P546
G3070A	1,000kg	70 x 70mm	500mm	310mm	-	P560

## SIDE WINDING BOX JACK



- Side winding square box jack
- Supplied with round flat base plate
- Suitable to be welded or bolted on to trailer drawbar
- Not for lifting

CODE	MAX NOSE WEIGHT	SIZE	CLOSED HEIGHT	STROKE
G3071	800kg	60 x 60mm	565mm	350mm

## HEAVY DUTY SIDE WINDING BOX JACK



- Heavy duty side winding square box jack
- Supplied with round flat base plate
- Suitable to be welded or bolted on to trailer drawbar
- Not for lifting

CODE	MAX NOSE WEIGHT	SIZE	CLOSED HEIGHT	STROKE
G18447	4,000kg	80 x 80mm	500mm	300mm

## HYDRAULIC BOX JACK



- Heavy duty hydraulic double acting square box jack
- Suitable to be welded or bolted on to trailers and implements
- Supplied with square folded base plate
- Not for lifting

CODE	MAX NOSE WEIGHT	SIZE	CLOSED HEIGHT	STROKE	OVERALL HEIGHT
G18448	3,800kg	110 x 110mm	750mm	400mm	735mm

## TOP WINDING ROUND BOX JACK



- Top winding round box jack
- Constructed for heavy duty trailer applications for example car transporter, horse box, livestock, plant and twin axle trailers
- Supplied with weld-on collar which can be rotated clear when not in use
- Supplied with with rectangular base plate
- Not for lifting

CODE	MAX NOSE WEIGHT	DIAMETER	CLOSED HEIGHT	STROKE
G19129	900kg	57mm	270mm	250mm
G19130	900kg	57mm	400mm	375mm

### ADDITIONAL IMAGES

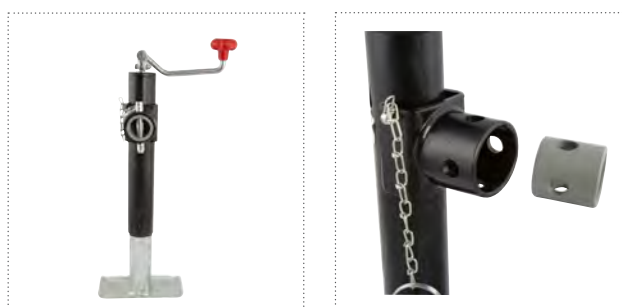

## SIDE WINDING ROUND BOX JACK



- Side winding round box jack
- Constructed for heavy duty trailer applications for example car transporter, horse box, livestock, plant and twin axle trailers
- Supplied with weld-on collar which can be rotated clear when not in use
- Supplied with rectangular base plate
- Not for lifting

CODE	MAX NOSE WEIGHT	DIAMETER	CLOSED HEIGHT	STROKE
G19131	2,250kg	57mm	260mm	250mm
G19132	2,250kg	57mm	400mm	375mm

### ADDITIONAL IMAGES



# TRAILER BRAKING

## HYDRA-SAFE BRAKING SYSTEM



- Agricultural trailer hydraulic emergency breakaway - brake
- In the case of trailer or towed braked implement detaching from tractor the brakes will be applied automatically
- Guaranteed Emergency Braking, with no electrical or additional connections
- G18361 - Suitable for single and twin axle trailers
- Comes with a large steel galvanised plate to attach trailer work pipes etc.
- G18362 - Suitable for Twin axle 35mm ram and Tri axle trailers
- Comes with a standard steel galvanised plate to attach trailer work pipes etc.
- G18363 - Suitable for Twin axle 35mm ram and Tri axle trailers
- Comes with a large steel galvanised plate to attach trailer work pipes etc.

CODE	SIZE	PLATE	SUITABILITY
G18361	1 x 1.4L Accumulator	Large	Single & Twin Axle Trailers
G18362	2 x 1.4L Accumulator	Standard	Twin & Tri Axle Trailers
G18363	2 x 1.4L Accumulator	Large	Twin & Tri Axle Trailers

## AUTO REVERSE AXLE BRAKE SHOE SETS



- Auto reverse brake shoe set for axles
- Includes brake shoes and return springs for a complete axle
- Suitable for Bradley and Knott - Avonride style brakes

CODE	WIDTH	DIAMETER	OE REF
G12434	35mm	160mm	SB001
G12435	40mm	203mm	SB002
G18562	40mm	203mm	-
G18563	50mm	200mm	-
G18564	40mm	250mm	-

## AL-KO STYLE AUTO REVERSE AXLE BRAKE SHOE SETS



- Auto reverse brake shoe set for axles (2 Hubs)
- Includes brake shoes and return springs for a complete axle
- Suitable for AL-KO style brakes

CODE	WIDTH	DIAMETER	REF
G19550	35mm	160mm	1635/1636/163
G19551	50mm	200mm	2050/2051
G19552	60mm	230mm	2360/2361

## HUB BRAKE SHOE SETS



- Brake shoes for one complete hub
- Includes brake shoes and return springs
- Suitable for ADR and similar agricultural trailer braked axles

CODE	WIDTH	DIAMETER
G12702	40mm	200mm
G12703	60mm	300mm
G13805	60mm	350mm

## BRAKE SHOE SPRING SETS

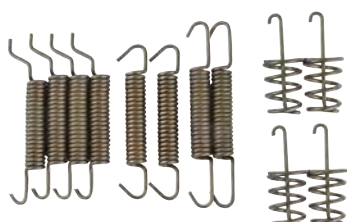

- Brake shoe return spring kit
- Includes 1 upper, 1 lower pull off and 1 steady spring

CODE	SUITABILITY	OE REF
G12452	G18562	SB020
G12455	G18564	SB023

## BRAKING CABLE



- Replacement brake cable for trailer braking assistance
- Attached between brake coupling and rear connection of axle hubs
- Protective sheath with connectors

CODE	LENGTH (COVER END - END)	OUTER DIAMETER
G3187A	1,000mm	10mm
G3187B	1,200mm	10mm
G19356	1,430mm	10mm
G13557	1,700mm	10mm
G19357	2,130mm	10mm

## AL-KO DETACHABLE BRAKING CABLE



- Replacement brake cable for AL-KO style brakes on trailer braking assistance
- Attached between brake coupling and rear connection of axle hubs
- Protective sheath with connectors



CODE	RANGE	OUTER DIAMETER
G19544	890 - 1,086mm	10mm
G19545	1,020 - 1,216mm	10mm
G19546	1,130 - 1,326mm	10mm
G19547	1,320 - 1,516mm	10mm
G19548	1,430 - 1,626mm	10mm
G19549	1,620 - 1,812mm	10mm

## TYPE 2 PARKING BRAKE



- Ratchet mechanism hand brake
- Suitable for agricultural trailers as a hand brake and emergency breakaway brake if required
- Suitable to be welded or bolted to trailer chassis

CODE	FITMENT	LENGTH	WIDTH	HOLE CENTRE	THREAD SIZE
G17141	2 Bolt	585mm Handle	260mm	200mm	10mm

## RATCHET PARKING BRAKE



- Pulley and threaded bar mechanism hand brake
- Suitable for agricultural trailers
- Handle is wound on the hand brake which tensions a wire rope cable resulting in the brakes being applied

CODE	FITMENT	LENGTH	WIDTH	HOLE CENTRE	THREAD SIZE
G17887	2 Bolt	345mm (225mm handle)	40mm	100mm	10mm

## RATCHET LEVER TRAILER PARKING BRAKE



- Ratchet hand brake suitable for trailers
- Supplied with round drum to wind wire rope when in use
- Fast release mechanism for releasing brakes
- 3 bolt fitment to front of trailer chassis
- Finish: zinc plated

CODE	FITMENT	LENGTH	WIDTH	HOLE CENTRE	THREAD SIZE	SUITABILITY
G19183	3 Bolt	550mm Handle	150mm	100mm	10mm	Up to 20mm Wire Rope

## BRAKE CABLE BRACKET



- Brake cable bracket
- Provides cable location at the back plate cable entry point
- Keeps brake cable in the correct position on the back plate of axle hub

CODE	LENGTH	WIDTH	THICKNESS	OE REF
G12464	86mm	68mm	2mm	SB032

## TRAILER AIR BRAKING

### AIR/HYDRAULIC ACTUATOR



- Dual internal sprung brake actuator
- Provides a hydraulic and pneumatic service brake combined in one unit
- Suitability: Single, Tandem, and Tri axle Trailers

CODE	TYPE	PORT	AIR PORT SIZE	ROD
G18166	T20	3/8in BSP	M16	25mm
G18167	T20	3/8in BSP	M16	30mm
G18168	T24	3/8in BSP	M16	30mm

### ECO LOAD SENSING RELAY VALVE



- Pneumatic load sensing valve
- Used to adjust the brake pressure in proportion to the load being carried
- Suitable for pneumatic brakes on agricultural trailers

CODE	TYPE	DIMENSIONS	MAX PRESSURE	SUITABILITY	AIR PORT SIZE
G18479	Female	210 x 120 x 120mm	10 Bar	Tandem and Tri axle trailers	M16/M22

### WABCO LOAD SENSING RELAY VALVE



- Wabco pneumatic load sending valve
- Used to adjust the brake pressure in proportion to the load being carried
- Suitable for for pneumatic brakes on agricultural trailers

CODE	TYPE	MAX PRESSURE	MATERIAL	SUITABILITY	AIR PORT SIZE	OE REF
G18419	Female	10 Bar	Aluminium	Tandem and Tri axle trailers	M16/M22	4757120000

### MANUAL LOAD PROPORTIONING VALVE



- Manual load proportioning valve
- Used to manually adjust brake pressure being applied in relation to the load being carried

CODE	TYPE	DIMENSIONS	MAX PRESSURE	SUITABILITY
G18477	Female	135 x 85 x 120mm	10 Bar	Manual load sensing valve

## ECO STANDARD RELAY VALVE



- Standard relay valve is used to evenly apply brake pressure to required axles

CODE	TYPE	DIMENSIONS	MAX PRESSURE	SUITABILITY	AIR PORT SIZE
G18478	Female	125 x 175 x 120mm	10 Bar	Single, Tandem and Tri axle trailers	M16/M22

## STRAP MOUNTED AIR BRAKE RESERVOIR



- Air reservoir tank used to store air for trailer braking systems
- Supplied with mounting strap

CODE	TYPE	CAPACITY	FINISH	AIR PORT SIZE
G18417	Female	60L	Black	M22

### ADDITIONAL IMAGES



## END MOUNTED AIR BRAKE RESERVOIR



- Air reservoir tank used to store air for trailer braking systems
- Supplied with end mounted bolt-on brackets

CODE	TYPE	CAPACITY	FINISH	AIR PORT SIZE
G18418	Female	60L	Black	M22

### ADDITIONAL IMAGES

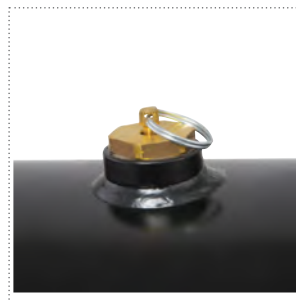

## AIR BRAKE HOSE

- High pressure nylon tubing for braking systems
- Material: Nylon



CODE	LENGTH	OUTER DIAMETER	THICKNESS	STANDARD	MAX PRESSURE	WORKING PRESSURE	COLOUR
G18428	30m	10mm	1.25mm	DIN 73378	57 Bar	19 Bar	Red
G18429	30m	10mm	1.25mm	DIN 73378	57 Bar	19 Bar	Yellow
G18430	30m	10mm	1.25mm	DIN 73378	57 Bar	19 Bar	Black
G18431	30m	12mm	1.5mm	DIN 74324	57 Bar	19 Bar	Black
G18432	30m	16mm	2mm	DIN 74324	57 Bar	19 Bar	Black
G18433	30m	18mm	2mm	DIN 74324	65 Bar	21 Bar	Black

## AIR BRAKE FLEXI COIL

- High-pressure nylon tubing coil for braking systems
- Supplied with M18 female end fittings both sides
- Thickness: 2mm
- Standard: DIN 74323/74324
- Material: Nylon



CODE	TYPE	LENGTH	OUTER DIAMETER	MAX PRESSURE	WORKING PRESSURE	COLOUR
G18434	Female x Female	4m	12mm	57 Bar	19 Bar	Yellow
G18435	Female x Female	4m	12mm	57 Bar	19 Bar	Red

## ANTI-KINK AIR BRAKE FLEXI COIL

- High-pressure nylon tubing coil for braking systems with anti-kink
- Supplied with M18 female end fittings both sides
- Thickness: 2mm
- Standard: DIN 74323/74324
- Material: Nylon



CODE	TYPE	LENGTH	OUTER DIAMETER	MAX PRESSURE	WORKING PRESSURE	COLOUR
G18436	Female x Female	4m	12mm	57 Bar	19 Bar	Black/Yellow
G18437	Female x Female	4m	12mm	57 Bar	19 Bar	Black/Red



## AIR BRAKE COIL HANDLES



- Tough and robust handle for nylon tubing coils Red and Yellow
- Makes connecting C-Couplings and Palm couplings easier
- Ergonomically designed grip for smooth handling
- Added support to the end of your coil

CODE	TYPE	DIMENSIONS	COLOUR	MATERIAL	AIR PORT SIZE
G18438	Male x Female	130 x 40 x 65mm	Yellow / Red	PVC	M16

## AIR BRAKE ADAPTOR



- Metric air brake adaptor in male x male configuration

CODE	TYPE	THREAD SIZE	FINISH
G18474	Male x Male	M18 x M16	Zinc Plated
G18427	Male x Male	M22 x M18	Zinc Plated

### ADDITIONAL IMAGES

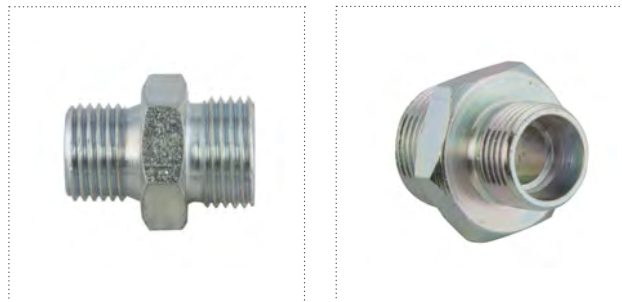

## INNER AIR BRAKE ADAPTOR



- Male reducer adaptor, M22 male thread outside with M16 female thread inside
- Reduces down from M22 female thread to M16 female thread

CODE	TYPE	THREAD SIZE	MATERIAL
G18473	Male x Female	M22 x M16	Brass

### ADDITIONAL IMAGES

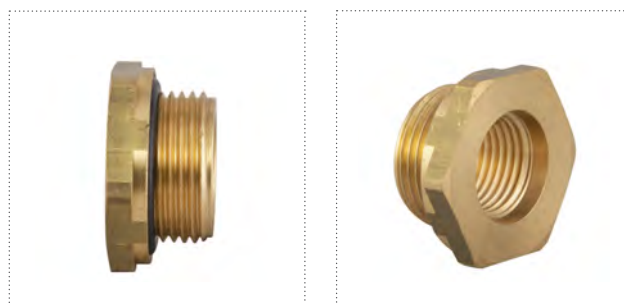

## STEPPED BULKHEAD AIR BRAKE ADAPTOR



- Stepped bulkhead adaptor with metric thread

CODE	INNER DIAMETER	THREAD SIZE	MATERIAL
G18471	M10	M22 x M16	Brass

## STRAIGHT BULKHEAD AIR BRAKE ADAPTOR



- Straight bulkhead adaptor with metric thread

CODE	INNER DIAMETER	THREAD SIZE	MATERIAL
G18472	M16	M22 x M22	Brass

### ADDITIONAL IMAGES

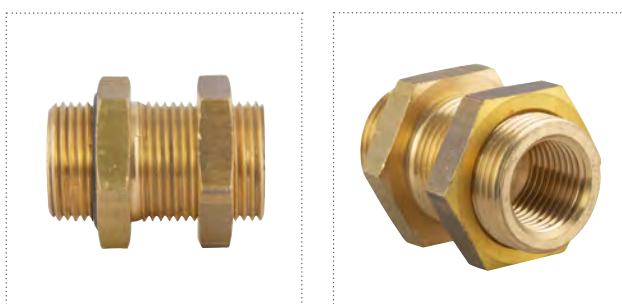

## AIR BRAKE STUD FITTINGS



- High-pressure straight brass fittings for braking systems
- Push in style

CODE	TYPE	INNER DIAMETER	THICKNESS	MATERIAL	AIR PORT SIZE
G18407	Male	10mm	1.25mm	Brass	M10
G18183	Male	10mm	1.25mm	Brass	M16
G18185	Male	12mm	1.5mm	Brass	M16
G18408	Male	10mm	1.25mm	Brass	M22
G18184	Male	12mm	1.5mm	Brass	M22
G18409	Male	16mm	2mm	Brass	M22
G18186	Male	18mm	2mm	Brass	M22

### ADDITIONAL IMAGES

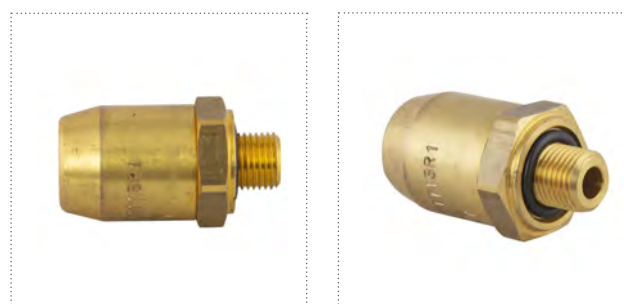

## AIR BRAKE STUD FITTINGS 90°

- High-pressure 90° brass fittings for braking systems
- Push in style



CODE	TYPE	INNER DIAMETER	THICKNESS	MATERIAL	AIR PORT SIZE
G18401	Male	10mm	1.25mm	Brass	M16
G18402	Male	12mm	1.5mm	Brass	M16
G18403	Male	10mm	1.25mm	Brass	M22
G18405	Male	16mm	2mm	Brass	M22
G18406	Male	18mm	2mm	Brass	M22

### ADDITIONAL IMAGES

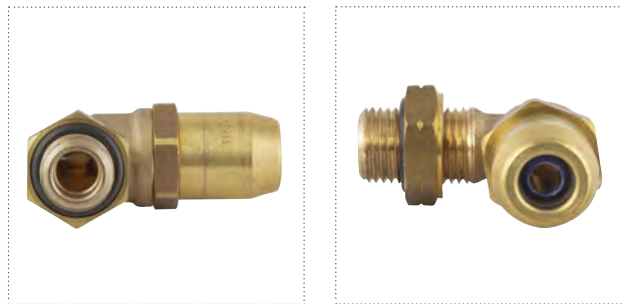

## AIR BRAKE REUSABLE FITTINGS

- High-pressure straight brass fittings for braking systems
- Reusable style



CODE	TYPE	INNER DIAMETER	THICKNESS	MATERIAL	AIR PORT SIZE
G18394	Male	10mm	1.25mm	Brass	M10
G18395	Male	10mm	1.25mm	Brass	M16
G18397	Male	10mm	1.25mm	Brass	M22

### ADDITIONAL IMAGES



## AIR BRAKE REUSABLE FITTINGS 90°

- High-pressure 90 degree brass fittings for braking systems
- Reusable style



CODE	TYPE	INNER DIAMETER	THICKNESS	MATERIAL	AIR PORT SIZE
G18388	Male	10mm	1.25mm	Brass	M16
G18390	Male	10mm	1.25mm	Brass	M22

### ADDITIONAL IMAGES



## AIR BRAKE PLUG FITTING

- High pressure male plug brass fittings with O-ring for braking systems



CODE	TYPE	MATERIAL	AIR PORT SIZE
G18190	Male	Brass	M16
G18410	Male	Brass	M22

### ADDITIONAL IMAGES



## AIR BRAKE DRAIN VALVE

- High-pressure air reservoir tank drain brass fitting for braking systems



CODE	TYPE	MATERIAL	AIR PORT SIZE
G18411	Male	Brass	M22

## AIR BRAKE DRAIN VALVE WITH CABLE

- High-pressure air reservoir tank drain brass fitting for braking systems
- Supplied with 6ft cable



CODE	TYPE	LENGTH	MATERIAL	AIR PORT SIZE
G18511	Male	6ft cable	Brass	M22

## AIR BRAKE TEST POINT

- High-pressure test point brass fittings for braking systems



CODE	TYPE	MATERIAL	AIR PORT SIZE
G18423	Male	Brass	M16
G18424	Male	Brass	M22 x M18

## AIR BRAKE THRUST RING

- Air brake coupling sealing thrust ring



CODE	THREAD SIZE
G18469	M16
G18470	M22

## AIR BRAKE O-RING

- Air brake coupling sealing O-ring



CODE	THREAD SIZE	MATERIAL
G18467	M16	Rubber
G18468	M22	Rubber

## AIR BRAKE COUPLING C-TYPE MALE

- Male C Type quick release coupling for air brakes
- Valveless



CODE	TYPE	LENGTH	THICKNESS	MATERIAL	FINISH	AIR PORT SIZE
G18414	Male	95mm	1.5mm	Brass	Yellow Passivated	M16

## AIR BRAKE COUPLING C-TYPE FEMALE



- Female C Type quick release coupling for air brakes
- Valveless

CODE	TYPE	LENGTH	INNER DIAMETER	THICKNESS	MATERIAL	FINISH	AIR PORT SIZE
G18413	Female	100mm	24mm	1.5mm	Brass	Yellow Passivated	M16

## INLINE FILTER



- Air brake system inline filter
- Removes contamination in air line

CODE	TYPE	MAX PRESSURE	SUITABILITY	AIR PORT SIZE
G18421	Female	20 Bar	Single, Tandem and Tri axle trailers	M22

## PALM TYPE AIR BRAKE COUPLING



- Palm type air brake quick release coupling

CODE	TYPE	COLOUR	THICKNESS	MATERIAL	AIR PORT SIZE
G18415	Female	Red	1.5mm	Aluminium	M22
G18416	Female	Yellow	1.5mm	Aluminium	M22

## SHUNT VALVE



- Air brake system shunt valve
- Allows for release of air brakes on trailers when being moved temporarily

CODE	TYPE	LENGTH	WIDTH	THICKNESS	THREAD SIZE
G18422	Female	125mm	45mm	1.5mm	M16

## AIR BRAKE 4 WAY VALVE



- Inline quick release air valve
- Applies brake pressure evenly in 4 different directions

CODE	TYPE	DIMENSIONS	AIR PORT SIZE
G18475	Female	70 x 95 x 55mm	M16/M22

# TRAILER AXLES, HUBS, SUSPENSIONS & ACCESSORIES

## AL-KO 4-STUD 100MM UNBRAKED HIGH SPEED STUB AXLE COMPLETE



- Stub axle with unbraked hub
- Studs: 4 x 12mm on 100mm PCD
- 375kg per hub up to 140km/h
- 500kg per hub up to 40km/h
- Round shaft 41mm od will fit 50mm box profile
- Flat surface on shaft to prevent twisting when fixed

CODE	CAPACITY	RANGE	SIZE	LENGTH	HOLE CENTRE	PCD	NO. STUDS
G19543	375kg	140km/h	41mm Round Shaft	120mm Shaft	85mm	100mm	4 Stud

## 6-STUD 400MM UNBRAKED STUB AXLE COMPLETE



- 6 stud unbraked stub axle with 205mm PCD
- Bearing type: 30208-32013
- Capacity up to 25 km/h single axle: 3,500kg
- Capacity up to 25 km/h tandem axle: 2,500kg
- Capacity up to 40 km/h single axle: 3,000kg
- Capacity up to 40 km/h tandem axle: 2,000kg

CODE	RANGE	SIZE	LENGTH	PCD	NO. STUDS	THREAD SIZE
G11051	40km/h	70mm Square	350mm Shaft	205mm	6 Stud	M18

## FIAT UNBRAKED HIGH SPEED HUB



- Stub axle with unbraked hub
- Studs: 4 x 12mm on 98mm PCD
- Taper roller bearings: 11949-11910; 44649-44610
- Seal: 212mm x 137mm x 37mm
- Capacity per stub: 375kg

CODE	RANGE	SIZE	LENGTH	PCD	NO. STUDS
G3081	100km/h	50mm Round	230mm Shaft	98mm	4 Stud

## FIAT UNBRAKED HUB



- Stub axle with unbraked hub
- Studs: 4 x 12mm on 98mm PCD
- Taper roller bearings: 30204; 30206
- Round shaft 41mm od will fit 50mm box profile
- Flat surface on shaft to prevent twisting when fixed
- Bolt holes on shaft 85mm centres diameter 13mm

CODE	RANGE	SIZE	LENGTH	HOLE CENTRE	PCD	NO. STUDS
G3080	40km/h	41mm Round	120mm Shaft	85mm	98mm	4 Stud

## FORD UNBRAKED HUB



- Stub axle with unbraked hub
- Studs: 4 x 1/2in UNF x 4.1/4in PCD
- Taper roller bearings: 48548-48510; 44649-44610
- Seal: 162 x 262 x 37mm
- Capacity per stub: 375kg

CODE	RANGE	SIZE	LENGTH	PCD	NO. STUDS
G3078	100km/h	50mm Round	240mm Shaft	4.1/4in-108mm	4 Stud

## HIACE UNBRAKED HUB



- Stub axle with unbraked hub
- Studs: 5 x 1/2in UNF x 4.1/2in PCD
- Taper roller bearings: 44649-44610; 48548-48510
- Seal: 162 x 262 x 37mm
- Shaft: 50mm round
- Capacity per stub: 375kg

CODE	RANGE	SIZE	LENGTH	PCD	NO. STUDS
G3182	100km/h	50mm Round	235mm Shaft	4.5in	5 Stud

## LAND ROVER UNBRAKED HUB



- Stub axle with unbraked hub
- Studs: 5 x 5/8in UNF on 6.1/2in PCD
- Taper roller bearings: 44649-44610; 48548-48510
- Seal: 162 x 262 x 37mm
- Shaft: 50mm RD
- Capacity per stub: 375kg

CODE	RANGE	SIZE	LENGTH	PCD	NO. STUDS
G3079	100km/h	50mm Round	235mm Shaft	6.5in	5 Stud



## UNBRAKED MINI HUB



- Replacement unbraked hub for mini suspension unit 175kg
- Studs: 4 x 3/8in UNF x 4in PCD
- Taper roller bearings: 44643-44610; 44600L-44610
- Supplied complete with grease cap

CODE	RANGE	CAPACITY	WIDTH	PCD	NO. STUDS
G3077	50km/h	175kg	65mm	4in	4 Stud

### ADDITIONAL IMAGES

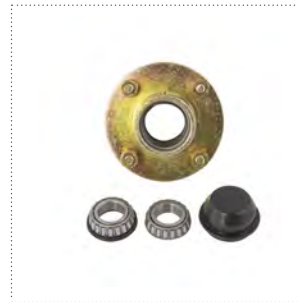

## UNBRAKED MINI AXLE STUB



- Replacement axle for mini suspension
- To be used with G3077

CODE	LENGTH	INNER DIAMETER
G3086C	135mm	1in

### ADDITIONAL IMAGES



## 6 STUD BRAKED STUB AXLE COMPLETE



- 6 stud braked stub axle with 205mm PCD
- Bearing type: 30208-32013
- Brake shoe: 300mm x 60mm
- Capacity up to 25 km/h single axle: 3,500kg
- Capacity up to 25 km/h tandem axle: 2,500kg
- Capacity up to 40 km/h single axle: 4,000kg
- Capacity up to 40 km/h tandem axle: 2,000kg

CODE	SIZE	LENGTH	PCD	NO. STUDS	THREAD SIZE
G11053	70mm Square	305mm Shaft	205mm	6 Stud	M18

## FIAT BRAKED HUB



- Braked stub axle
- Studs: 4 x 12mm on 98mm PCD
- Brake shoe size: 200mm x 40mm
- Taper roller bearings: 30204-30206
- Capacity up to 25km/h single axle: 825kg
- Capacity up to 25km/h tandem axle: 625kg
- Capacity up to 40km/h single axle: 725kg
- Capacity up to 40kh/h tandem axle: 575kg

CODE	SIZE	LENGTH	PCD	NO. STUDS	THREAD SIZE
G3083	40mm Square	180mm Shaft	98mm	4 Stud	M12

## FIAT AUTO-REVERSE HUB & CABLE



- Fiat braked auto reverse stub axle
- Brakes: 200 x 50mm auto reverse
- Taper roller bearings: 11949 -11910, 44649-44610
- Seal: 212 x 137 x 37mm
- Supplied complete with cables
- Capacity: 450kg each - 900kg per set
- Range: 100km/h

CODE	SIZE	LENGTH	PCD	NO. STUDS	THREAD SIZE	POSITION
G3082	50mm Round	200mm Shaft	98mm	4 Stud	M12	Left
G13552	50mm Round	200mm Shaft	98mm	4 Stud	M12	Right

## FORD AUTO-REVERSE HUB & CABLE



- Ford auto reverse braked 4 stud UNF stub axle on 4.1/4in PCD
- Brakes: 200 x 50mm auto reverse
- Taper roller bearings: 48548-48510, 44649-44610
- Seal: 162 x 262 x 37mm
- Supplied complete with cables
- Capacity: 500kg each - 1000kg per set
- Range: 100km/h

CODE	SIZE	LENGTH	PCD	NO. STUDS	POSITION
G3183	50mm Round	180mm Shaft	4.1/4in-108mm	4 Stud	Left
G13553	50mm Round	180mm Shaft	4.1/4in-108mm	4 Stud	Right

## HIACE AUTO-REVERSE HUB & CABLE



- Hiace auto reverse braked 5 stud stub axle on 4.1/2in PCD
- Brakes: 200 x 50mm auto reverse
- Taper roller bearings: 48548-48510, 44649-44610
- Seal: 162 x 262 x 37mm
- Supplied complete with cables
- Capacity: 500kg each- 1000kg per set
- Range: 100km/h

CODE	SIZE	LENGTH	PCD	NO. STUDS	POSITION
G3184	50mm Round	205mm Shaft	4.5in	5 Stud	Left
G13554	50mm Round	205mm Shaft	4.5in	5 Stud	Right

## LAND ROVER 750KG AUTO-REVERSE HUB & CABLE



- Land Rover braked auto reverse 5 stud stub axle on 6.1/2in PCD
- Brakes: 200 x 50mm auto reverse
- Taper roller bearings: 48548-48510, 44649-44610
- Seal: 162 x 262 x 37mm
- Supplied complete with cables
- Capacity: 750kg each- 1500kg per set
- Range: 100km/h

CODE	SIZE	LENGTH	PCD	NO. STUDS	POSITION
G3185	50mm Round	215mm Shaft	6.5in	5 Stud	Left
G13555	50mm Round	215mm Shaft	6.5in	5 Stud	Right

## LAND ROVER 900KG AUTO-REVERSE HUB & CABLE



- Land rover braked auto reverse 5 stud stub axle on 6.1/2in PCD
- Brakes: 250 x 40mm auto reverse
- Taper roller bearings: 48548- 48510, 18690-18620
- Seal: 206 x 318 x 45mm
- Supplied complete with cables
- Capacity: 900kg each- 1800kg per set
- Range: 100km/h

CODE	SIZE	LENGTH	PCD	NO. STUDS	POSITION
G3186	60mm Round	230mm Shaft	6.5in	5 Stud	Left
G13556	60mm Round	230mm Shaft	6.5in	5 Stud	Right

## AUTO REVERSE 4 STUD 100MM PCD HUB SET 900KG



- ALKO braked stub axle set
- Brake shoe: 160 x 35mm auto reverse
- Studs: 4 x 12mm on 100mm PCD
- Extension: 170 x 50mm round
- Supplied complete with cables
- Capacity: 900kg per pair
- Range: 140km/h

CODE	SIZE	LENGTH	PCD	NO. STUDS	OE REF
G19522	50mm Round	170mm Shaft	100mm	4 Stud	1225204

### ADDITIONAL IMAGES



## AUTO REVERSE 4 STUD 100MM PCD HUB SET 1500KG



- ALKO Braked stub axle set
- Brake shoe: 200 x 50mm auto reverse
- Studs: 4 x 12mm on 100mm PCD
- Extension: 85 x 50mm Round
- Supplied complete with cables
- Capacity: 1,500kg per pair x 2 bolt fixing
- Range: 140km/h

CODE	SIZE	LENGTH	HOLE CENTRE	PCD	NO. STUDS	OE REF
G19524	50mm Round	135mm Shaft	85mm	100mm	4 Stud	1732766

### ADDITIONAL IMAGES



## AUTO REVERSE 4 STUD 5.5INCH PCD HUB SET 1500KG



- ALKO Braked stub axle set
- Brake shoe: 200 x 50mm auto reverse
- Studs: 4 x 12mm on 5.5inch (139.7mm) PCD
- Extension: 85 x 50mm Round
- Supplied complete with cables
- Capacity: 1,500kg per pair x 2 bolt fixing
- Range: 140km/h

CODE	SIZE	LENGTH	HOLE CENTRE	PCD	NO. STUDS	OE REF
G19525	50mm Round	135mm Shaft	85mm	5.5in	4 Stud	1730107

### ADDITIONAL IMAGES



## AUTO REVERSE 4 STUD 108MM PCD HUB SET 1500KG



- ALKO Braked stub axle set
- Brake shoe: 200 x 50mm auto reverse
- Studs: 4 x 12mm on 108mm PCD
- Extension: 85 x 50mm Round
- Supplied complete with cables
- Capacity 1,500kg per pair, x 2 bolt fixing
- Range: 140km/h

CODE	SIZE	LENGTH	HOLE CENTRE	PCD	NO. STUDS	OE REF
G19527	50mm Round	135mm Shaft	85mm	108mm	4 Stud	1731589

### ADDITIONAL IMAGES



## AUTO REVERSE 4 STUD 115MM PCD HUB SET 1,500KG



- ALKO Braked stub axle set
- Brake shoe: 200 x 50mm auto reverse
- Studs: 4 x 12mm on 115mm PCD
- Extension: 85 x 50mm Round
- Supplied complete with cables
- Capacity: 1,500kg per pair x 2 bolt fixing
- Range: 140km/h

CODE	SIZE	LENGTH	HOLE CENTRE	PCD	NO. STUDS	OE REF
G19528	50mm Round	135mm Shaft	85mm	115mm	4 Stud	1731590

### ADDITIONAL IMAGES



## AUTO REVERSE 5 STUD 112MM PCD HUB SET 900KG



- ALKO Braked stub axle set
- Brake shoe: 160mm x 35mm auto reverse
- Studs: 5 x 12mm on 112mm PCD
- Extension: 170 x 50mm round
- Supplied complete with cables
- Capacity: 900kg per pair
- Range: 140km/h

CODE	SIZE	LENGTH	PCD	NO. STUDS	OE REF
G19523	50mm Round	170mm Shaft	112mm	5 Stud	1225997

### ADDITIONAL IMAGES

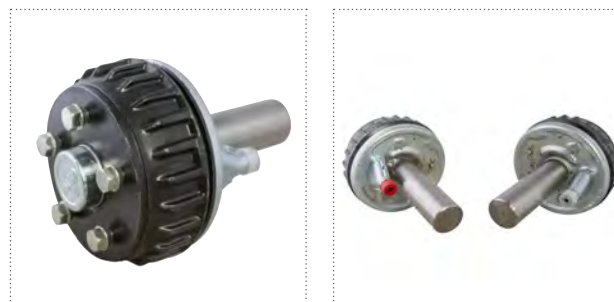

## AUTO REVERSE 5 STUD 112MM PCD HUB SET 1,500KG



- ALKO Braked stub axle set
- Brake shoe: 200mm x 50mm auto reverse
- Studs: 5 x 12mm on 112mm PCD
- Extension: 85 x 50mm Round
- Supplied complete with cables
- Capacity: 1,500kg per pair x 2 bolt fixing
- Range: 140km/h

CODE	SIZE	LENGTH	HOLE CENTRE	PCD	NO .STUDS	OE REF
G19526	50mm Round	135mm Shaft	85mm	112mm	5 Stud	1225472

### ADDITIONAL IMAGES



## AUTO REVERSE 5 STUD 115MM PCD HUB SET 1,500KG



- ALKO Braked stub axle set
- Brake shoe: 200mm x 50mm auto reverse
- Studs: 5 x 12mm on 115mm PCD
- Extension: 85 x 50mm Round
- Supplied complete with cables
- Capacity: 1,500kg per pair x 2 bolt fixing
- Range: 140km/h

CODE	SIZE	LENGTH	HOLE CENTRE	PCD	NO .STUDS	OE REF
G19529	50mm Round	135mm Shaft	85mm	115mm	5 Stud	1730725

### ADDITIONAL IMAGES



## 6 STUD 1750MM BRAKED AXLE COMPLETE



- 6 stud braked axle with 205mm PCD
- 70mm square shaft on axle fitted with ADR brakes 300mm x 60mm
- Bearing type: 30208-32013
- Brake shoe: 300mm x 60mm
- Capacity up to 25 km/h single axle: 7,000kg
- Capacity up to 25 km/h tandem axle: 5,000kg
- Capacity up to 40 km/h single axle: 6,000kg
- Capacity up to 40 km/h tandem axle: 4,000kg

CODE	RANGE	SIZE	HUB F- HUB F LENGTH	PCD	NO. STUDS	THREAD SIZE
G8940	40km/h	70mm Square	1,750mm	205mm	6 Stud	M18

### ADDITIONAL IMAGES

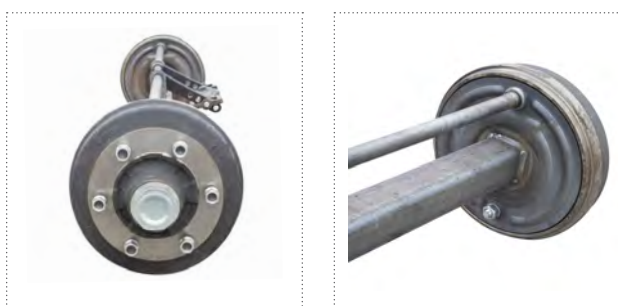

## FIAT HIGH SPEED SOLID UNBRAKED AXLE



- Fiat style 4 stud unbraked solid axle with 98mm PCD
- Bearing type: 11949-11910, 44649-44610
- Seal: 212 x 137 x 37mm
- Range: 100km/h

CODE	CAPACITY	SIZE	HUB F- HUB F LENGTH	PCD	NO. STUDS	THREAD SIZE
G13259	1,000kg	40mm Square Shaft	66in (1,675mm)	98mm	4 Stud	M12

### ADDITIONAL IMAGES





## FIAT HIGH SPEED SOLID BRAKED AXLE



- Fiat style 4 stud braked solid axle with 98mm PCD
- Supplied complete with cables
- Bearing type: 11949-11910, 44649-44610
- Seal: 212 x 137 x 37mm
- Brake shoe: 200 x 50mm
- Range: 100km/h

CODE	CAPACITY	SIZE	HUB F- HUB F LENGTH	PCD	NO. STUDS	THREAD SIZE
G13258	1,000kg	40mm Square Shaft	66in (1,675mm)	98mm	4 Stud	M12

### ADDITIONAL IMAGES



## LAND ROVER 1,500KG HIGH SPEED SOLID BRAKED AXLE



- Land Rover style 5 stud solid braked axle with 165.1mm PCD
- Bearing type: 44649-44610, 48548-48510
- Seal: 162 x 262 x 37mm
- Brake shoe 200mm x 50mm
- Supplied complete with cables
- Range: 100km/h

CODE	CAPACITY	SIZE	HUB F- HUB F LENGTH	PCD	NO. STUDS	THREAD SIZE
G13260	1,500kg	45mm Square Shaft	74in (1,880mm)	165.1mm	5 Stud	5/8in
G13261	1,500kg	45mm Square Shaft	80in (2,032mm)	165.1mm	5 Stud	5/8in

### ADDITIONAL IMAGES



## FIAT BRAKED SUSPENSION AXLE



- Fiat style 4 stud braked suspension unit with 98mm PCD
- Bearing type: 11949-11910, 44649-44610
- Seal: 212 x 137 x 37mm
- Brake shoe: 200 x 50mm
- Supplied complete with cables
- Range: 100km/h

CODE	CAPACITY	SIZE	HUB F- HUB F LENGTH	HOLE CENTRES	PCD	NO. STUDS	THREAD SIZE
G13254	1,000kg	80mm Square	66in (1675mm)	1316 x 160mm	98mm	4 Stud	M12

### ADDITIONAL IMAGES



## LAND ROVER BRAKED SUSPENSION AXLE



- Land Rover style 5 stud braked suspension unit with 165.1mm PCD
- Bearing type: 44649-44610, 48548-48510
- Seal: 162 x 262 x 37mm
- Brake shoe: 200mm x 50mm
- Supplied complete with cables
- Range: 100km/h

CODE	CAPACITY	SIZE	HUB F- HUB F LENGTH	HOLE CENTRES	PCD	NO. STUDS	THREAD SIZE
G13255	1,500kg	80mm Square	74in (1,880mm)	1464 x 160mm	165.1mm	5 Stud	5/8in
G13256	1,500kg	80mm Square	80in (2,032mm)	1616 x 160mm	165.1mm	5 Stud	5/8in

### ADDITIONAL IMAGES





## AL-KO UNBRAKED SUSPENSION AXLE



- AL-KO style 4 stud unbraked suspension unit with 100mm PCD
- Bearing type: 11949-11910, 44649-44610
- Seal: 212 x 137 x 37mm
- Brake shoe: 200 x 50mm
- Range: 140km/h

CODE	SIZE	HUB F- HUB F LENGTH	HOLE CENTRES	PCD	NO. STUDS	THREAD SIZE
G19521	70mm Hex	62in (1580mm)	1200 x 160mm	100mm	4 Stud	M12

### ADDITIONAL IMAGES



## FIAT UNBRAKED SUSPENSION AXLE



- Fiat style 4 stud unbraked suspension unit with 98mm PCD
- Bearing type: 11949-11910, 44649-44610
- Seal: 212 x 137 x 37mm
- Range: 100km/h

CODE	CAPACITY	SIZE	HUB F- HUB F LENGTH	HOLE CENTRES	PCD	NO. STUDS	THREAD SIZE
G13257	1,000kg	80mm Square	66in (1675mm)	1316 x 160mm	98mm	4 Stud	M12

### ADDITIONAL IMAGES



## UNBRAKED SUSPENSION UNIT 500KG



- 4 stud unbraked suspension unit set with 4in PCD
- Capacity: 250kg each per unit (500kg per pair)
- Range: 100km/h

CODE	CAPACITY	SIZE	OVERALL LENGTH	HOLE CENTRES	PCD	NO. STUDS	THREAD SIZE
G19519	500kg	50mm Square	370mm. 210mm Shaft	155 x 80mm	4in	4 Stud	M10

### ADDITIONAL IMAGES



## UNBRAKED SUSPENSION UNIT 750KG



- 4 stud unbraked suspension unit set with 4in PCD
- Capacity: 375kg per unit (750kg per pair)
- Range: 100km/h

CODE	CAPACITY	SIZE	OVERALL LENGTH	HOLE CENTRES	PCD	NO. STUDS	THREAD SIZE
G19520	750kg	60mm Square	500mm 320mm Shaft	220 x 100mm	100mm	4 Stud	M12

### ADDITIONAL IMAGES



## FIAT UNBRAKED SUSPENSION UNIT



- 4 stud unbraked suspension unit with 98mm PCD
- Range: 90km/h
- Bearings: 11949-11910, 44649-44610
- Seal: 212 x 137 x 37mm
- Can be fitted with 13in wheels with 98mm PCD
- Capacity: 375kg each per unit (750kg per pair)
- Range: 100km/h

CODE	SIZE	LENGTH	HOLE CENTRES	PCD	NO. STUDS	POSITION
G14400	64mm Square	355mm Shaft	150 x 100mm	98mm	4 Stud	Left
G14401	64mm Square	355mm Shaft	150 x 100mm	98mm	4 Stud	Right

PICTURE SHOWN  
(LEFT HAND)

## FIAT BRAKED SUSPENSION UNIT



PICTURE SHOWN  
(LEFT HAND)

- Fiat braked auto reverse 4 stud suspension unit on 98mm PCD
- Range: 100km/h
- Brakes: 200 x 50mm auto reverse
- Taper roller bearings: 11949-11910, 44649-44610
- Seal: 212 x 137 x 37mm
- Supplied complete with cables
- Capacity: 375kg each per unit (750kg per pair)
- Thread size: M12
- Range: 100km/h

CODE	SIZE	LENGTH	HOLE CENTRES	PCD	NO. STUDS	POSITION
G14409	64mm Square	540mm. 355mm Shaft	150 x 100mm	98mm	4 Stud	Left
G14410	64mm Square	540mm. 355mm Shaft	150 x 100mm	98mm	4 Stud	Right

### ADDITIONAL IMAGES

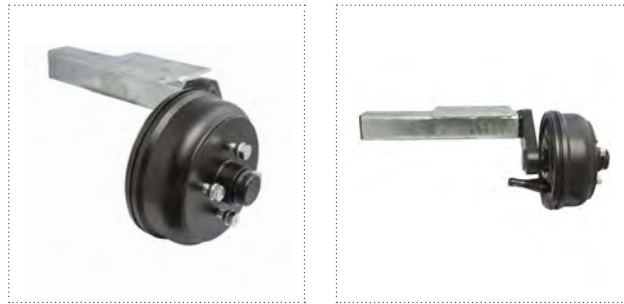

## 175KG MINI SUSPENSION UNIT



PICTURE SHOWN  
(RIGHT HAND)

- 4 stud unbraked mini suspension unit with 4inch PCD
- Capacity: 175kg per unit; 350kg capacity per pair
- Forged arms 4 stud hub
- Bearings: 44643-44610; 44600L-44610
- Capacity: 175kg each per unit (350kg per pair)
- Thread: M10
- Range: 50km/h

CODE	SIZE	LENGTH	HOLE CENTRES	PCD	NO. STUDS	POSITION
G3087	50mm Square	345mm	150 x 80mm	4in	4 Stud	Left
G3088	50mm Square	345mm	150 x 80mm	4in	4 Stud	Right

## 250KG MINI SUSPENSION UNIT

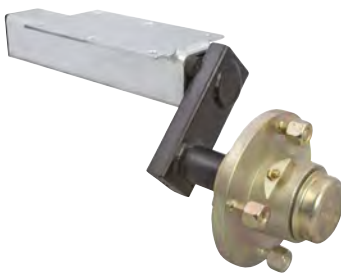

PICTURE SHOWN  
(RIGHT HAND)

- 4 stud unbraked mini suspension unit with 4inch PCD
- Capacity: 250kg per unit; 500kg capacity per pair
- Forged arms 4 stud hub
- Bearings: 44643-44610; 44600L-44610
- Capacity: 250kg each per unit (500kg per pair)
- Thread: M10
- Range: 100km/h

CODE	SIZE	LENGTH	HOLE CENTRES	PCD	NO. STUDS	POSITION
G3090	50mm Square	410mm	150 x 80mm	4in	4 Stud	Left
G3091	50mm Square	410mm	150 x 80mm	4in	4 Stud	Right

## LEAF SPRING



- Multi leaf trailer spring
- Different capacities available depending on size of spring
- Load capacities stated per pair

CODE	CAPACITY	LENGTH	WIDTH	NO. OF LEAFS	MAXIMUM LOAD
G3072	750kg per pair	762 mm (30in)	50.8 mm	2	600kg
G3073	1,000kg per pair	762 mm (30in)	50.8 mm	3	800kg
G3074	1,300kg per pair	762 mm (30in)	50.8 mm	4	1040kg
G3075	1,500kg per pair	762 mm (30in)	50.8 mm	5	1200kg
G3075A	1,800kg per pair	762 mm (30in)	50.8 mm	7	1440kg
G3076	2,000kg per pair	1066.8 mm (42in)	50.8 mm	5	1600kg

### ADDITIONAL IMAGES



## LEAF SPRING U-BOLT KIT



- Finish: zinc plated
- Material: Grade EN8
- Supplied with nuts and plate

CODE	DIMENSIONS	THREAD SIZE	COLOUR
G3111	3in x 2in (76.2 x 50.8mm)	M12	Silver
G3110	5in x 2in (127 x 50.8mm)	M12	Silver
G3166	5in x 2in (127 x 50.8mm)	M16	Silver
G3109A	7in x 2in (177.8 x 50.8mm)	M12	Silver

## LEAF SPRING BRACKET



- Bolt on bracket for holding leaf spring on trailers
- Finish: zinc plated

CODE	DIMENSIONS	THICKNESS	BOLT SIZE	FINISH
G14064	95 x 64 x 52mm	6mm	M14 fixing	Zinc Plated

## LEAF SPRING U-BOLT ONLY



- Material: Grade EN8
- Finish: zinc plated

CODE	DIMENSIONS	THREAD SIZE	MATERIAL	FINISH
G17698	80 x 50mm	M16	Steel	Zinc Plated
G3111A	80 x 130mm	M16	Steel	Zinc Plated
G17843	100 x 100mm	M16	Steel	Zinc Plated

## COUPLING SKID 70MM



- Skid bracket suitable for light duty trailer
- Fixing under 2 bolt hitch or drawbar
- Finish: zinc plated

CODE	WIDTH	HOLE CENTRE	MATERIAL	FINISH
G17207	125mm	85mm	Steel	Zinc Plated

## TRAILER DROP PLATE - UNIVERSAL



- Trailer 6 hole plate suitable for vehicle towbars
- Can be used with light duty trailers to adjust towing height
- Finish: Zinc Plated

CODE	DIMENSIONS	HOLE CENTRE	MATERIAL	FINISH
G17208	150 x 140 x 10mm	4in (100.6 x 90mm)	Steel	Zinc Plated

## DRAWBAR SPRING



- Used to absorb shock load when towing
- Suitable for large trailers and tankers

CODE	CAPACITY	LENGTH	OUTER DIAMETER	INNER DIAMETER
G8935A	15Ton (15,000kg)	250mm	107mm	54mm
G17740	20Ton (20,000kg)	250mm	110mm	57mm

## GREASE CAP



- Replacement plastic grease cap for hub
- Retains grease inside hub to ensure bearings are lubricated
- Keeps the bearings and wheel hub clean from dust and debris

CODE	OUTER DIAMETER	MATERIAL	FINISH
G15806	73mm	Plastic	Black
G15807	75mm	Plastic	Black

## PUSH-IN GREASE CAP



- Replacement push in PVC grease cap for hub
- Retains grease inside hub to ensure bearings are lubricated
- Keeps the bearings and wheel hub clean from dust and debris

CODE	OUTER DIAMETER	MATERIAL	FINISH
G17461	76mm	PVC	Grey

## SCREW-IN GREASE CAP



- Replacement plastic grease cap for hub
- Retains grease inside hub to ensure bearings are lubricated
- Keeps the bearings and wheel hub clean from dust and debris

CODE	OUTER DIAMETER	MATERIAL	FINISH
G16476	72mm	Plastic	Black

## PVC MINI HUB GREASE CAP



- Replacement PVC grease cap for mini ATV hub
- Retains grease inside hub to ensure bearings are lubricated
- Keeps the bearings and wheel hub clean from dust and debris

CODE	OUTER DIAMETER	MATERIAL	FINISH
G14670	50.8mm	PVC	Black

## ATV HUB GREASE CAP



- Replacement PVC grease cap for ATV hub
- Retains grease inside hub to ensure bearings are lubricated
- Keeps the bearings and wheel hub clean from dust and debris

CODE	OUTER DIAMETER	MATERIAL	FINISH
G17826	52.5mm	PVC	Black



## STEEL MINI HUB GREASE CAP



- Replacement steel grease cap for mini hub
- Retains grease inside hub to ensure bearings are lubricated
- Keeps the bearings and wheel hub clean from dust and debris

CODE	OUTER DIAMETER	MATERIAL	FINISH
G15053	50.8mm	Pressed Steel	Yellow Passivated

## N-SERIES GREASE CAP



- Replacement 2 piece steel grease cap pack
- Suitable for Knott Avonride N series hub
- Retains grease inside hub to ensure bearings are lubricated
- Keeps the bearings and wheel hub clean from dust and debris

CODE	OUTER DIAMETER	FINISH	OE REF
G12461	52.4mm	Zinc Plated	SB029

## ACE SERIES GREASE CAP



- Replacement 2 piece steel grease cap pack
- Suitable for Knott Avonride A, C, E and F series hubs
- Retains grease inside hub to ensure bearings are lubricated
- Keeps the bearings and wheel hub clean from dust and debris

CODE	OUTER DIAMETER	FINISH	OE REF
G12462	47.1mm	Zinc Plated	SB030

63

## R-SERIES GREASE CAP



- Replacement steel grease cap
- Suitable for Knott Avonride R series hub
- Retains grease inside hub to ensure bearings are lubricated
- Keeps the bearings and wheel hub clean from dust and debris

CODE	OUTER DIAMETER	FINISH	OE REF
G12460	60.3mm	Zinc Plated	SB028

## VT-SERIES GREASE CAP



- Replacement steel grease cap
- Suitable for Knott Avonride V and T series hub
- Retains grease inside hub to ensure bearings are lubricated
- Keeps the bearings and wheel hub clean from dust and debris

CODE	OUTER DIAMETER	FINISH	OE REF
G12463	74.6mm	Zinc Plated	SB031

## AXLE GREASE CAP FOR FIAT HUB



- Replacement steel grease cap
- Suitable for Fiat hub
- Retains grease inside hub to ensure bearings are lubricated
- Keeps the bearings and wheel hub clean from dust and debris

CODE	OUTER DIAMETER	MATERIAL	FINISH
G13446	47mm	Pressed Steel	Silver

## AXLE GREASE CAP



- Replacement steel grease cap
- Suitable for ADR or similar hub
- Retains grease inside hub to ensure bearings are lubricated
- Keeps the bearings and wheel hub clean from dust and debris

CODE	OUTER DIAMETER	MATERIAL	FINISH
G12710	60mm	Pressed Steel	Silver
G12711	80mm	Pressed Steel	Silver
G13804	85mm	Pressed Steel	Zinc Plated
G14668	90mm	Pressed Steel	Zinc Plated
G12712	100mm	Pressed Steel	Silver
G14669	110mm	Pressed Steel	Zinc Plated

## WHEEL BEARING KIT SB005



- Taper roller bearing kit suitable for Knott avonride type hubs
- Bearing and seal kit for x 1 complete hub
- Supplied with 2 bearings and 1 seal
- Bearings: 48548-48510, 67048-67010
- Seal: 275 175 37

CODE	SUITABILITY	BEARINGS	SEAL	OE REF
G12438	V&T HUB	48548-48510, 67048-67010	275 175 37	SB005 571000
G12439	C&E HUB	44649-44610, 32004x	38 x 52 x 8mm	SB006 571001
G12441	N HUB	44643-44610, 44643-44610	Included in the bearing	SB008 571003
G12442	N HUB	44649-44610 67048-67010	Inner: 42mm Outer: 63.5mm Depth: 9mm	SB009 571004

## TRAILER WHEELS, KITS, STUDS, NUTS & TUBES

### 4-STUD WHEEL ASSEMBLY 145/80 R10 74N



- Wheel and tyre assembly
- Tyre size: 145/80 R10 74N
- E-mark: E4-02111803
- Tubeless
- Max pressure: 50 PSI
- Stud: 10mm (11.5) / 12mm (14.5)
- Suitability: light trailer

CODE	NO. STUDS	CAPACITY	SIZE	RIM DIAMETER	PCD
G19473	4 Stud	375kg	67mm centre	10in	4in
G19474	4 Stud	375kg	60mm centre	10in	100mm

### 4-STUD WHEEL ASSEMBLY 145 R10C 84/82N



- Wheel and tyre assembly
- Tyre size: 145 R10C 84/82N
- E-mark: E4-0041994
- Tubeless
- Max pressure: 65 PSI
- Stud: 12mm (13.7)
- Suitability: trailer only

CODE	NO. STUDS	CAPACITY	SIZE	RIM DIAMETER	PCD
G19475	4 Stud	500kg	95mm centre	10in	5.5in

### 4-STUD WHEEL ASSEMBLY 4.80/4.00-8



- Wheel and tyre assembly
- Tyre size: 4.80/4.00-8
- E-mark: E11-001101
- Tubeless
- Max pressure: 60 PSI
- Stud: 12mm
- Suitability: high speed trailer

CODE	NO. STUDS	CAPACITY	SIZE	RIM DIAMETER	PCD
G19492	4 Stud	265kg	60mm centre	8in	100mm

### 4-STUD WHEEL ASSEMBLY 500/10 72M



- Wheel and tyre assembly
- Tyre size: 500/10 72M
- E-mark: E4-0028500
- Tubeless
- Max pressure: 40 PSI
- Stud: 14mm (14.5)
- Suitability: light truck

CODE	NO. STUDS	CAPACITY	SIZE	RIM DIAMETER	PCD
G19472	4 Stud	355kg	60mm centre	10in	100mm

### 4-STUD WHEEL ASSEMBLY 155/80 R13 84N



- Wheel and tyre assembly
- Tyre size: 155/80 R13 84N
- E-mark: E4-02111142
- Tubeless
- Max pressure: 50 PSI
- Stud: 14mm (15.5)
- Suitability: trailer only

CODE	NO. STUDS	CAPACITY	SIZE	OFFSET	RIM DIAMETER	PCD
G19477	4 Stud	500kg	56mm centre	30mm	13in	100mm

### 4-STUD WHEEL ASSEMBLY 165 R13C 96-94N



- Wheel and tyre assembly
- Tyre size: 165 R13C 96-94N
- E-mark: E4-0041626
- Tubeless
- Max pressure: 65 PSI
- Stud: 14mm (14.5)
- Suitability: trailer only

CODE	NO. STUDS	CAPACITY	SIZE	OFFSET	RIM DIAMETER	PCD
G19478	4 Stud	710kg	95mm centre	25.4mm	13in	5.5in

### FIAT 4-STUD WHEEL ASSEMBLY



- Wheel and tyre assembly
- Remould tyre on 4 stud 98mm PCD rim with offset
- Tyre size: G3096 165 x 70 x 13. G3097 175 x 70 x 14
- Max pressure: 36 PSI
- Stud: G3096 12mm. G3097 14mm

CODE	NO. STUDS	CAPACITY	SIZE	RIM DIAMETER	PCD
G3096	4 Stud	525kg	58mm centre	13in	98mm
G3097	4 Stud	700kg	60mm centre	14in	98mm

### MINI 4-STUD WHEEL ASSEMBLY



- Wheel and tyre assembly
- Tyre size: 400 x 8
- Max pressure: 60 PSI
- Stud: 10mm

CODE	NO. STUDS	CAPACITY	SIZE	RIM DIAMETER	PCD
G3094	4 Stud	265kg	68mm centre	8in	4in

## BOAT TRAILER 4-STUD WHEEL ASSEMBLY



- Wheel and tyre assembly
- Tyre size: 520 x 10
- Max pressure: 40 PSI
- Stud: 10mm

CODE	NO. STUDS	CAPACITY	SIZE	RIM DIAMETER	PCD
G3095	4 Stud	355kg	68mm centre	10in	4in

## 4-STUD 4 PLY ROAD TYRE WHEEL ASSEMBLY



- Wheel and road tyre assembly
- High speed tyre
- Tyre size: 20.5 x 8
- Stud: 12mm

CODE	NO. STUDS	CAPACITY	SIZE	RIM DIAMETER	PCD
G19470	4 Stud	425kg	60mm centre	10in	100mm

## 4-STUD KNOBBY TYRE WHEEL ASSEMBLIES



- Wheel and tyre assembly
- Tyre size: 22 x 11 x 8
- Stud: 4 stud rim with offset
- Tyre style: grass knobby style
- Not recommended for road use

CODE	NO. STUDS	RATING	SIZE	PCD
G19469	4 Stud	6ply	60mm centre	100mm
G8730	4 Stud	6ply	68mm centre	4in
G18490	4 Stud	4ply	60mm centre	100mm

## MUD/SAND WHEEL ASSEMBLY



- Wheel and tyre assembly
- Tyre size: 18 x 9.5 x 8
- Stud: 4 stud 98mm PCD rim with offset
- Tyre style: mud / sand style

CODE	NO. STUDS	RATING	SIZE	PCD
G8729	4 Stud	6ply	60mm centre	98mm

### 5-STUD WHEEL ASSEMBLY 185/60 R12C 104/102N



- Wheel and tyre assembly
- Tyre size: 185/60 R12C 104/102N
- E-mark: E4-0041822
- Tubeless
- Max pressure: 95 PSI
- Stud: 18mm (18.5)
- Suitability: trailer only

CODE	NO. STUDS	CAPACITY	SIZE	RIM DIAMETER	PCD
G19476	5 Stud	900kg	115mm centre	12in	165.1mm

### 5-STUD WHEEL ASSEMBLY 6.50 R16 108-107N



- Wheel and tyre assembly
- Tyre size: 6.50 R16 108-107N
- E-mark: E4-024050
- Tubeless
- Max pressure: 73 PSI
- Stud: 18mm (18.5)
- Suitability: trailer

CODE	NO. STUDS	CAPACITY	SIZE	OFFSET	RIM DIAMETER	PCD
G19480	5 Stud	1,000kg	115mm centre	39.7mm	16in	165.1mm

### 5-STUD WHEEL ASSEMBLY 185 R14C 104-102N



- Wheel and tyre assembly
- Tyre size: 185 R14C 104-102N
- E-mark: E4-0041821
- Tubeless
- Max pressure: 65 PSI
- Stud: 14mm (15.5)
- Suitability - Trailer only

CODE	NO. STUDS	CAPACITY	SIZE	OFFSET	RIM DIAMETER	PCD
G19479	5 Stud	900kg	67mm centre	30mm	14in	112mm

### 5-STUD LAND ROVER WHEEL ASSEMBLY



- Wheel and tyre assembly
- Tyre sizes: G16537 155/70/12, G3100N 185/70/13 and G3098 195/50/13
- Stud: 18mm
- Suitability: for Williams and Indespension trailers

CODE	NO. STUDS	RATING	CAPACITY	SIZE	RIM DIAMETER	PCD
G16537	5 Stud	6ply	850kg	115mm centre	12in	6.5in
G3100N	5 Stud	6ply	900kg	115mm centre	13in	6.5in
G3098	5 Stud	6ply	850kg	115mm centre	13in	6.5in

### 4-STUD WHEEL RIM 4IN & 100MM PCD



- Replacement steel rim
- Finish: silver RAL 9006

CODE	NO. STUDS	CAPACITY	SIZE	RIM DIAMETER	PCD
G19481	4 Stud	355kg	67mm centre	8in	4in
G19482	4 Stud	450kg	67mm centre	10in	4in
G19483	4 Stud	500kg	60mm centre	10in	100mm

### 4-STUD WHEEL RIM 5.5IN PCD



- Replacement steel rim
- Finish: silver RAL 9006

CODE	NO. STUDS	CAPACITY	SIZE	OFFSET	RIM DIAMETER	PCD
G19485	4 Stud	765kg	95.5mm centre	25.4mm	13in	5.5in

### 5-STUD WHEEL RIM 165.1MM PCD



- Replacement steel rim
- Finish: silver RAL 9006

CODE	NO. STUDS	CAPACITY	SIZE	OFFSET	RIM DIAMETER	PCD
G19484	5 Stud	900kg	114.5mm centre	N/A	12in narrow	165.1mm
G19489	5 Stud	900kg	114.5mm centre	N/A	12in wide	165.1mm
G19486	5 Stud	950kg	114.5mm centre	7mm	13in	165.1mm

### 5-STUD WHEEL RIM 112MM & 165.1MM PCD



- Replacement steel rim
- Finish: silver RAL 9006

CODE	NO. STUDS	CAPACITY	SIZE	OFFSET	RIM DIAMETER	PCD
G19487	5 Stud	950kg	67mm centre	30mm	14in	112mm
G19488	5 Stud	900kg	115mm centre	39.7mm	16in	165.1mm

## ATV TRAILER KIT



- Complete ATV trailer kit
- Supplied with:
  - 2 x wheel assemblies
  - Tyre size: 22 x 11
  - 2 x 4-stud stub axles 35mm x 35mm square x 190mm long 100mm PCD
  - Stub axle capacity: up to 25km/h 750kg per pair, up to 90km/h 500kg per pair
  - 1 x pressed hitch suitable for 50mm drawbar (Hitch capacity: 750kg)

CODE	NO. STUDS	CAPACITY	PCD
G19445	4 Stud	Hitch = 750kg	100mm

## AXLE STUD



- Replacement wheel hub stud
- Stud comes with knurled finish for easy fixing to hubs

CODE	SIZE	LENGTH	THREAD SIZE
G12707	12 x 40mm x 1.5	40mm	12mm
G12705	16 x 50mm x 1.5	50mm	16mm
G11096	18 x 50mm x 1.5	50mm	18mm
G13801	18 x 65mm x 1.5	65mm	18mm
G13560	18 x 81mm x 1.5	81mm	18mm
G14671	20 x 76mm	76mm	20mm
G15511	22 x 65mm x 1.5	65mm	22mm
G16989	10 x 38mm	38mm	10mm

## WHEEL STUD KIT SB017



- M12 x 38mm wheel studs x 5 piece kit
- Suitable for Knott Avonride A series hubs

CODE	LENGTH	THREAD SIZE	OE REF
G12450	38mm	12mm	SB017

## WHEEL STUD KIT SB055



- M16 x 47mm wheel studs x 5 piece kit
- Suitable for Knott Avonride series hubs

CODE	LENGTH	THREAD SIZE	OE REF
G12487	47mm	16mm	SB055



## AXLE NUT



- Conical style axle nut
- Available in three sizes: 16mm, 18mm and 22mm

CODE	SIZE	THREAD SIZE	FINISH
G12706	16mm x 1.5	16mm	Zinc Plated
G11097	18mm x 1.5	18mm	Zinc Plated
G11099	22mm x 1.5	22mm	Zinc Plated

## AXLE NUT WITH WASHER



- Axle nut plain
- Thread size: 20mm
- Supplied with conical washer

CODE	THREAD SIZE	FINISH
G14614	20mm	Zinc Plated

## AXLE NUT WITH SPLIT PIN KIT



- Axle split pin and castellated nut kit
- Comes with x 2 axle nuts, washers and clips
- Suitable for Knott Avonride style hubs

CODE	THREAD SIZE	FINISH	OE REF
G12459	3/4in	Zinc Plated	SB027

## SPHERICAL NUT KIT METRIC SB011



- Metric spherical nut x 5 piece kits
- Thread size: 12mm
- Suitable for Knott Avonride style hubs

CODE	THREAD SIZE	OE REF
G12444	12mm	SB011

## SPHERICAL NUT KIT METRIC SB053



- Metric spherical nut x 5 piece kit
- Suitable for Knott Avonride style hubs

CODE	THREAD SIZE	OE REF
G12485	16mm	SB053

## SPHERICAL NUT KIT UNF SB010



- UNF Spherical nut x 5 piece kit
- Suitable for Knott Avonride style hubs

CODE	THREAD SIZE	OE REF
G12443	3/8in	SB010

## CONICAL WHEEL NUT KIT



- Conical axle nut x 5 piece kits
- Suitable for Knott Avonride style hubs

CODE	THREAD SIZE	OE REF
G12445	12mm	SB012
G12484	16mm	SB052

## ROAD TYRE



- Mini road wheel replacement tyre
- Suitable for use on many domestic trailers inc. boat trailers

CODE	TYPE	RATING	TYRE SIZE	MATERIAL
G8722	Road Tyre	6ply	400 x 8	Black Rubber

## TYRE TUBE



- Replacement inner tube
- Supplied with valve and cap

CODE	TUBE SIZE	MATERIAL
G8734	300 x 4	Black Rubber
G8735	350 x 6	Black Rubber
G8736	400 x 4	Black Rubber
G8737	350/400 x 8	Black Rubber
G8740	600 x 9	Black Rubber

## TRAILER BODY PARTS

### PIN & CHAIN



- Flat plate pin and chain loose style for trailer side boards
- Suits G2920

CODE	LENGTH	THICKNESS	MATERIAL	FINISH
G2918	100mm	4mm	Mild Steel	Zinc Plated

### ROUND PIN & CHAIN



- Round pin and chain for tipping trailer forket on back doors
- Suits G2952, G2955

CODE	LENGTH	THICKNESS	MATERIAL	FINISH
G2957	125mm	8mm	Mild Steel	Zinc Plated
G2954	150mm	10mm	Mild Steel	Zinc Plated

### SPRING TYPE PIN & CHAIN



- Flat plate pin and chain spring type for trailer side boards
- Suits G2920

CODE	LENGTH	THICKNESS	MATERIAL	FINISH
G2919	82mm	4mm	Mild Steel	Zinc Plated

### CATCH BOX PIN

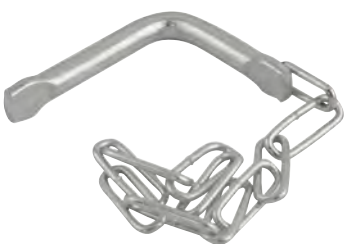

- Round pin and chain for trailer catch box on back door
- Suits G3000A, G14045

CODE	SHAFT LENGTH	THICKNESS	MATERIAL	FINISH
G3000	70mm	10mm	Mild Steel	Zinc Plated

## SLOTTED PEG



- Forged slotted peg used with pin and chain to hold trailer side boards in place
- Suits G2918, G2919

CODE	LENGTH	OUTER DIAMETER	INNER DIAMETER	MATERIAL	FINISH
G2920	50mm	1/2in	20mm	Forged Steel	Self Colour

## BOLT-ON ANTI-LUCE



- Bolt-on anti-luce device for closing trailer side boards and back doors

CODE	TYPE	LENGTH	THREAD SIZE	THREAD LENGTH	FINISH
G2915	Bolt-on	115mm	M12	35mm	Zinc Plated
G2916	Bolt-on	155mm	M12	75mm	Zinc Plated

## BOLT-ON BABY ANTI-LUCE



- Mini bolt-on anti-luce device for closing light duty trailer side boards and doors

CODE	TYPE	LENGTH	THREAD SIZE	THREAD LENGTH	FINISH
G2912A	Bolt-on	95mm	M8	35mm	Zinc Plated

## WELD-ON ANTI-LUCE



- Weld-on anti-luce device for closing trailer side boards and back doors

CODE	TYPE	LENGTH	OUTER DIAMETER	FINISH
G2914	Weld-on	92mm	12mm	Zinc Plated

## WELD-ON BABY ANTI-LUCE



- Mini weld-on anti-luce device for closing light duty trailer side boards and doors

CODE	TYPE	LENGTH	OUTER DIAMETER	FINISH
G2913	Weld-on	65mm	8mm	Zinc Plated

## ANTI-LUCE PLATE



- Wel-on or bolt-on latching plate
- For use with anti-luce device for closing trailer side boards and back doors

CODE	LENGTH	WIDTH	THICKNESS	HOLE DIAMETER	FINISH
G15029	125mm	40mm	5mm	22mm	Zinc Plated
G3135	250mm	40mm	5mm	22mm	Zinc Plated

## WELD-ON GUDGEON



- Weld-on forged hinge suitable for trailer side board hinging
- Pin sizes: 1/2in and 5/8in

CODE	OVERALL LENGTH	SHAFT LENGTH	THICKNESS	MATERIAL	FINISH
G2921	100mm	50mm	1/2in	Forged Steel	Self Colour
G2923	115mm	50mm	5/8in	Forged Steel	Self Colour

## WELD-ON GUDGEON BZP



- Weld-on forged hinge suitable for trailer side board hinging

CODE	OVERALL LENGTH	SHAFT LENGTH	THICKNESS	MATERIAL	FINISH
G15058	100mm	50mm	1/2in	Forged Steel	Zinc Plated

## BOLT-ON GUDGEON BZP



- Bolt-on forged hinge suitable for trailer side board hinging
- Pin sizes: 1/2in

CODE	OVERALL LENGTH	SHAFT LENGTH	THICKNESS	HOLE CENTRES	MATERIAL	FINISH
G2924	150mm	50mm	1/2in	40mm	Forged Steel	Zinc Plated

## STRAIGHT HINGE



- Weld-on rolled hinge suitable for trailer side board hinging
- Hole sizes: 1/2in and 5/8in

CODE	LENGTH	WIDTH	THICKNESS	HOLE DIAMETER	MATERIAL	FINISH
G2927	80mm	40mm	8mm	1/2in	Mild Steel Formed	Self Colour
G2928	80mm	40mm	8mm	5/8in	Mild Steel Formed	Self Colour

## LONG HINGE

- Weld-on rolled hinge suitable for trailer side board hinging



CODE	LENGTH	WIDTH	THICKNESS	HOLE DIAMETER	MATERIAL	FINISH
G2934A	101.6mm	30mm	6mm	1/2in	Mild Steel Formed	Self Colour
G2934B	152.4mm	30mm	6mm	1/2in	Mild Steel Formed	Self Colour
G2929	145mm	40mm	8mm	1/2in	Mild Steel Formed	Self Colour
G2930	140mm	40mm	8mm	5/8in	Mild Steel Formed	Self Colour
G2931	460mm	40mm	8mm	1/2in	Mild Steel Formed	Self Colour

## SELF COLOUR FORGED HINGE

- Heavy duty weld-on forged hinge suitable for heavy duty trailer side board hinging



CODE	LENGTH	WIDTH	HOLE DIAMETER	MATERIAL
G2990	95mm	75mm	1/2in	Forged Steel
G2992	95mm	75mm	5/8in	Forged Steel

## SINGLE SLOT BZP HINGE

- Bolt-on rolled hinge suitable for trailer side board hinging



CODE	LENGTH	WIDTH	THICKNESS	HOLE DIAMETER	MATERIAL	FINISH
G14868	105mm	30mm	8mm	1/2in	Mild Steel	Zinc Plated

## DOUBLE SLOT BZP HINGE

- Bolt-on rolled hinge suitable for trailer side board hinging



CODE	LENGTH	WIDTH	THICKNESS	HOLE CENTRE	HOLE DIAMETER	MATERIAL	FINISH
G15057	168mm	40mm	8mm	60mm	1/2in	Mild Steel	Zinc Plated

## WELD-ON ROPE HOOK S/C



- Weld-on heavy duty forged rope hook with flat plate for positioning

CODE	LENGTH	WIDTH	THICKNESS	MATERIAL	FINISH
G14864	140mm	30mm	18mm	Forged Steel	Self Colour

## BOLT-ON ROPE HOOK ZINC PLATED



- Bolt-on heavy duty forged rope hook with flat plate for positioning

CODE	LENGTH	WIDTH	THICKNESS	HOLE CENTRES	MATERIAL	FINISH
G14863	140mm	30mm	18mm	50mm	Forged Steel	Zinc Plated

## BOLT-ON ROPE HOOK



- Bolt-on forged rope hook with flat plate for positioning

CODE	LENGTH	WIDTH	THICKNESS	HOLE CENTRE	MATERIAL
G2997	100mm	25mm	10mm	40mm	Forged Steel
G2997A	138mm	25mm	12mm	50mm	Forged Steel

## LIGHTWEIGHT ROPE HOOK



- Lightweight bolt-on fabricated general purpose vehicle rope hook

CODE	LENGTH	WIDTH	THICKNESS	HOLE CENTRE	MATERIAL	FINISH
G3147	89mm	22mm	5mm	35mm	Fabricated Mild Steel	Zinc Plated

## WELD-ON C-TYPE ROPE HOOK



- Weld-on C-shaped type rope hook

CODE	WIDTH	THICKNESS	MATERIAL	FINISH
G2994	80mm	12mm	Mild Steel	Self Colour
G2994A	80mm	16mm	Mild Steel	Self Colour

## 4 HOLE CARGO TIE DOWN



- Trailer cargo tie down lashing points
- Bolt-on with 4 bolt mounting
- Fold up D-ring with recessed plate so it sits flush with the trailer floor

CODE	LENGTH	WIDTH	INNER DIAMETER	HOLE CENTRE	MATERIAL	FINISH
G17213	100mm	95mm	40mm	80 x 75mm	Mild Steel	Zinc Plated

## 6 HOLE CARGO TIE DOWN



- Trailer cargo tie down lashing points
- Bolt-on with 6 bolt mounting
- Fold up D-ring with recessed plate so it sits flush with the trailer floor

CODE	LENGTH	WIDTH	INNER DIAMETER	HOLE CENTRE	MATERIAL	FINISH
G17214	145mm	105mm	40mm	120 x 85mm	Mild Steel	Zinc Plated

## CARGO TIE DOWN D-RING

- Weld-on trailer cargo D-ring
- Comes with D-shaped ring lashing point and U bracket for welding to trailer surface
- Surface mounted



CODE	LENGTH	WIDTH	INNER DIAMETER	THICKNESS	MATERIAL	FINISH
G17797	88mm	80mm	55mm	1/2in	Forged Steel	Self Colour
G17798	107mm	105mm	76mm	5/8in	Forged Steel	Self Colour
G17799	110mm	115mm	74mm	3/4in	Forged Steel	Self Colour
G17800	127mm	127mm	76mm	1in	Forged Steel	Self Colour

## BOLT-ON CARGO TIE DOWN DELTA RING



- Bolt-on trailer cargo delta ring
- Finish: galvanised
- Surface mounted

CODE	LENGTH	INNER DIAMETER	THICKNESS	HOLE CENTRE	FINISH
G18324	180mm	50mm	12mm	45mm	Galvanized



## WELD-ON CARGO TIE DOWN DELTA RING



- Weld-on trailer cargo delta ring
- Finish: self colour
- Surface mounted

CODE	LENGTH	INNER DIAMETER	THICKNESS	FINISH
G18325	180mm	50mm	12mm	Self Colour

## FORKET WITH PLATE



- Weld-on forket with plate for positioning
- Suitable for trailer rear door hinging and closing
- Used with trailer lug

CODE	LENGTH	INNER DIAMETER	HOLE DIAMETER	MATERIAL	FINISH
G2952	90mm	3/4in	8mm	Forged Steel	Self Colour
G2955	110mm	1in	8mm	Forged Steel	Self Colour

## TRAILER LUG



- Weld-on trailer lug with plate for positioning
- Suitable for trailer rear door hinging and closing
- Used with trailer forket with plate

CODE	LENGTH	OUTER DIAMETER	MATERIAL	FINISH
G2953	135mm	3/4in	Forged Steel	Self Colour
G2956	145mm	1in	Forged Steel	Self Colour

## LOCKING BAR TAB



- Locking bar tab for trailer rear door closing
- Suitable for welding onto locking bar in order to close trailer rear door

CODE	LENGTH	INNER DIAMETER	MATERIAL	FINISH
G3001	80mm	3/4in	Forged Steel	Self Colour
G3001A	80mm	1in	Forged Steel	Self Colour

## LOCKING BAR HOOK



- Locking bar hook suitable for trailer rear door closing
- Weld-on, suitable for bar size 3/4in and 1in

CODE	INNER DIAMETER	MATERIAL	FINISH
G3002	3/4in	Forged Steel	Self Colour
G3002A	1in	Forged Steel	Self Colour

## BRACKET FOR LOCKING BAR



- Bracket for holding locking bar for trailer rear door closing
- 2 bolt mounting

CODE	LENGTH	INNER DIAMETER	HOLE CENTRE	MATERIAL	FINISH
G3003	90mm	3/4in	70mm	Forged Steel	Self Colour
G3003A	90mm	1in	70mm	Forged Steel	Self Colour

## CATCH BOX



- Weld-on trailer rear door catch box used for holding locking bar in place
- Used with pin and chain G3000

CODE	LENGTH	INNER DIAMETER	WIDTH	MATERIAL	FINISH
G3000A	52mm	3/4in	50mm	Fabricated Mild Steel	Self Colour
G14045	52mm	1in	50mm	Fabricated Mild Steel	Self Colour

## RAMP FASTENER COMPLETE



- Weld-on trailer door ramp fastener
- Standard UNC thread
- Suitable for closing rear door of livestock trailers and trucks

CODE	THREAD SIZE	MATERIAL	FINISH
G2937	1/2in	Forged Steel	Self Colour
G2940	5/8in	Forged Steel	Self Colour With Zinc Plated Threaded Bar

## ACME RAMP FASTENER



- Weld-on trailer door ramp fastener
- ACME thread
- Suitable for closing rear door of livestock trailers and trucks

CODE	THREAD SIZE	MATERIAL	FINISH
G3136	5/8in ACME	Forged Steel	Self Colour With Zinc Plated Threaded Bar

## RAMP FASTENER PLATE



- Replacement weld-on trailer door ramp fastener plate

CODE	LENGTH	HOLE DIAMETER	MATERIAL	FINISH
G2936	145mm	1/2in	Forged Steel	Self Colour
G2939	145mm	5/8in	Forged Steel	Self Colour

## RAMP DOOR SPRING



- Trailer door ramp spring
- Suitable for livestock trailers and truck ramps

CODE	LENGTH	OUTER DIAMETER	THICKNESS	MATERIAL	FINISH
G3138	305mm	40mm	6mm	Mild Steel Coiled	Galvanized
G3139	305mm	52mm	9.5mm	Mild Steel Coiled	Galvanized
G3140	406mm	40mm	6mm	Mild Steel Coiled	Galvanized
G12297	406mm	40mm	9.5mm	Mild Steel Coiled	Galvanized
G2943	610mm	50mm	9.5mm	Mild Steel Coiled	Galvanized
G17765	610mm	50mm	9.5mm	Mild Steel Coiled	Yellow Passivated
G2941	610mm	40mm	6mm	Mild Steel Coiled	Galvanized
G12690	610mm	40mm	8mm	Mild Steel Coiled	Galvanized
G2942	610mm	50mm	8mm	Mild Steel Coiled	Galvanized
G2944	997mm	60mm	9.5mm	Mild Steel Coiled	Galvanized
G2945	994mm	60mm	11mm	Mild Steel Coiled	Galvanized

## TORSION SPRING



- Trailer torsion spring suitable for low loader ramps
- Material: mild steel coiled
- Finish: Black Primer

CODE	DIMENSIONS	WIDTH	OUTER DIAMETER	THICKNESS	POSITION
G3151	300 x 50 x 16mm	460mm	83mm	16mm	Left
G3152	300 x 50 x 16mm	460mm	83mm	16mm	Right
G3112	300 x 40 x 20mm	460mm	83mm	20mm	Left
G3112A	300 x 40 x 20mm	460mm	83mm	20mm	Right

PICTURE SHOWN  
(RIGHT HAND)

## SINGLE PVC MUDGUARD



- Single axle trailer mudguard
- Black plastic mudguard made of polypropylene
- Resistant to minor bumps and scrapes
- Flat flange for ease of fitting to side of trailer
- Suitable for 8in to 14in wheels

CODE	LENGTH	WIDTH	HEIGHT	MATERIAL
G3167	490mm	140mm	195mm	Black Plastic
G3168	620mm	180mm	240mm	Black Plastic
G3168A	760mm	220mm	335mm	Black Plastic

## DOUBLE PVC MUDGUARD (SINGLY)



- Double axle trailer mudguard
- Sold singly
- Black plastic mudguard made of polypropylene
- Resistant to minor bumps and scrapes
- Flat flange for ease of fitting to side of trailer
- Suitable for 14in to 16in wheels

CODE	LENGTH	WIDTH	HEIGHT	MATERIAL
G3168B	1,500mm	160mm	510mm	Black Plastic
G3168C	1,750mm	210mm	530mm	Black Plastic

## DOUBLE PVC MUDGUARD (PAIRS)



- Double axle trailer mudguard
- Sold in pairs i.e. order x1 = x2 mudguards
- Black plastic mudguard made of polypropylene
- Resistant to minor bumps and scrapes
- Flat flange for ease of fitting to side of trailer
- Suitable for 14in to 16in wheels

CODE	LENGTH	WIDTH	HEIGHT	MATERIAL
G19735	1,220mm	190mm	250mm	Black Plastic
G19736	1,500mm	160mm	510mm	Black Plastic
G19737	1,540mm	215mm	450mm	Black Plastic
G19738	1,750mm	210mm	530mm	Black Plastic

## TRAILER CARGO NET

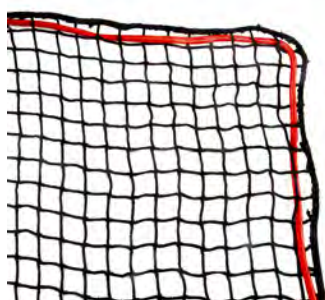

- Trailer net to secure cargo and goods inside open back trailers during transport
- Available in different sizes
- Elastic edging cord allows for securing netting to trailer edge via rope hooks or tie down points

CODE	LENGTH	WIDTH
G19530	2,200mm	1,500mm
G19531	2,200mm	1,600mm
G19532	3,500mm	2,500mm
G19533	5,000mm	3,500mm

## BOAT TRAILER PARTS

### SINGLE SIDE ROLLER

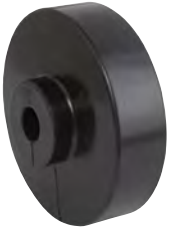

- Single boat trailer side roller

CODE	HEIGHT	OUTER DIAMETER	INNER DIAMETER	MATERIAL	SUITABILITY
G3115	58mm	106mm	16mm	Rubber	G3114

### SIDE ROLLER DUMBBELL



- Dumbbell / double boat trailer side roller

CODE	LENGTH	OUTER DIAMETER	INNER DIAMETER	MATERIAL	SUITABILITY
G3117	114mm	102mm	16mm	Rubber	G3116

### V-KEEL ROLLER



- V shaped boat trailer roller

CODE	LENGTH	OUTER DIAMETER	INNER DIAMETER	MATERIAL	SUITABILITY
G3120	127mm	56mm	16mm	Rubber	G3118

### KEEL ROLLER



- Keel boat trailer roller

CODE	LENGTH	OUTER DIAMETER	INNER DIAMETER	MATERIAL	SUITABILITY
G3119	127mm	51-70mm	16mm	Rubber	G3118

### PARALLEL SIDE ROLLER



- Long parallel boat trailer roller

CODE	LENGTH	OUTER DIAMETER	INNER DIAMETER	MATERIAL	SUITABILITY
G3122	203mm	57mm	16mm	Rubber	G3121

## SINGLE SIDE ASSEMBLY ROLLER WITH TUBE



- Single boat trailer side roller support bracket
- Suitable for x 2 single side rollers
- 16mm diameter spindle

CODE	DIMENSIONS	LENGTH	MATERIAL	FINISH	SUITABILITY
G3114	60 x 43 x 60mm	200mm	Mild Steel Fabricated	Zinc Plated	G3115

## DOUBLE SIDE ROLLER DUMBBELL WITH TUBE

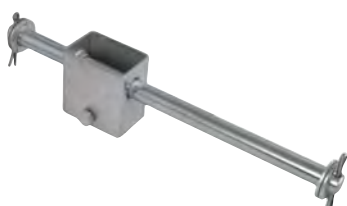

- Dumbbell / double boat trailer side roller support bracket
- Suitable for x 2 double side rollers
- 16mm diameter spindle

CODE	DIMENSIONS	LENGTH	MATERIAL	FINISH	SUITABILITY
G3116	60 x 43 x 60mm	300mm	Mild Steel Fabricated	Zinc Plated	G3115 / G3117

## KEEL ROLLER BRACKET



- Boat trailer keel roller support bracket
- Suitable for 5in 'V' and Dumbbell roller
- 16mm diameter spindle
- Punched to take suitable u-bolt clamp

CODE	DIMENSIONS	LENGTH	MATERIAL	FINISH	SUITABILITY
G3118	147 x 50 x 77mm	130mm	Mild Steel Fabricated	Zinc Plated	G3119 / G3120

## SIDE ROLLER BRACKET WITH TUBE



- Boat trailer side roller support bracket
- Suitable for 203mm parallel roller
- 16mm diameter spindle
- Fits 34mm diameter support stem

CODE	DIMENSIONS	LENGTH	MATERIAL	FINISH	SUITABILITY
G3121	222 x 40 x 90mm	210mm	Mild Steel Fabricated	Zinc Plated	G3122

## BRACKET CHANNEL



- Boat trailer channel bracket

CODE	DIMENSIONS	THICKNESS	HOLE CENTRE	MATERIAL	FINISH	SUITABILITY
G3132	300 x 40 x 30mm	30mm	230mm	Mild Steel Fabricated	Zinc Plated	G3130 / G3131

## BOAT TRAILER BLOCK



- Rectangle boat trailer rubber block
- 2 bolt mounting

CODE	DIMENSIONS	HOLE CENTRES	THREAD SIZE	MATERIAL	SUITABILITY
G3130	300 x 44 x 25mm	230mm	M8	Rubber	G3132

## 4-HOLE BOAT TRAILER BLOCK



- Rectangle boat trailer rubber block
- 4 hole mounting

CODE	DIMENSIONS	HOLE CENTRES	THREAD SIZE	MATERIAL	SUITABILITY
G3131	300 x 38 x 19mm	230mm	M8	Rubber	G3132

## BOAT TRAILER HULL SUPPORT PAD



- Boat trailer hull rubber support pad
- 2 bolt mounting

CODE	DIMENSIONS	HOLE CENTRE	THREAD SIZE	MATERIAL
G3133	160 x 45 x 46mm	90mm	M10	Rubber

## 2-HOLE BOAT TRAILER BLOCK



- Boat trailer heavy duty rubber block
- 2 hole mounting

CODE	DIMENSIONS	HOLE CENTRE	THREAD SIZE	MATERIAL
G3127	200 x 50 x 53mm	100mm	M12	Rubber

# TRAILER MACHINE RAMPS

## STRAIGHT ALUMINIUM RAMP



- Compact loading ramps made from aluminium
- Suitable for small and medium loads
- Smooth transition from loading edge to ramp
- High grip due to non slip perforated profile
- Durable and corrosion resistant
- TUV tested
- Maximum permitted ramp gradient is 30%
- Ramp must be anchored on the loading surface
- Supplied in pairs

CODE	TYPE	CAPACITY	LENGTH	WIDTH	MATERIAL
G19536	Straight	400kg	2,000mm	225mm	Aluminium
G19537	Straight	1,000kg	2,000mm	260mm	Aluminium

### ADDITIONAL IMAGES



## CURVED ALUMINIUM RAMP



- Compact loading ramps made from aluminium
- Suitable for small and medium loads
- Smooth transition from loading edge to ramp
- High grip due to non slip perforated profile
- Durable and corrosion resistant
- TUV tested
- Maximum permitted ramp gradient is 30%
- Ramp must be anchored on the loading surface
- Supplied in pairs

CODE	TYPE	CAPACITY	LENGTH	WIDTH	MATERIAL
G19534	Curved	400kg	1,500mm	215mm	Aluminium
G19535	Curved	400kg	2,000mm	225mm	Aluminium

### ADDITIONAL IMAGES





# ADDITIONAL TRAILER CATALOGUE PRODUCTS

## LED MAGNETIC LIGHTING SET



CODE: **G17753**

- Voltage: **12V**
- 4 function: brake/ indicator/ tail/ number plate
- Pre-wired: 7.5m cable, male 7 pin plug
- EU approved light cluster

## LED TRAILER LIGHTING BOARD (4FT X 5M)



CODE: **G17750**

- ALTERNATIVE SIZES AVAILABLE**
- Voltage: **12V**
  - Electrics: **7 pin**
  - Bracket with fixing screws and bolts
  - EU approved light clusters
  - Lamps: 2 x LED 4 function lamps (stop/tail/indicator/number plate)
  - Reflectors: 2 x triangle

## TRAILER LIGHTING BOARD (4FT X 5M)



CODE: **G2748**

- ALTERNATIVE SIZES AVAILABLE**
- Voltage: **12V**
  - Suitable for all types of trailers
  - EU approved light clusters
  - Incorporates a brake/side light and indicator light
  - Incorporates dual reflector triangle

## LED GLO-TRAC RECTANGULAR REAR LAMP SET



CODE: **G18527**

- Voltage: **12V / 24V**
- 3 Function
- Stop/Tail/Indicator
- 5 Pin Connector

## LED 3 FUNCTION RECTANGULAR CABLE KIT



CODE: **G18579**

- ALTERNATIVE SIZES AVAILABLE**
- Easy and fast installation
  - Waterproof durable strong connector
  - Customisable cable length

## LED ROUND REAR COMBI LAMP



CODE: **G17237**

- Voltage: **12/24V**
- 3 function stop/tail/indicator
- Plastic base plate
- With fixing screws & wires
- Spade connectors

Our Additional Trailer Products includes relevant products from a variety of alternative sections that Genfitt can provide. Please visit [www.genfitt.ie](http://www.genfitt.ie) or ask your local representative for more details on any of our additional products included in this catalogue.

**LED RECTANGULAR REAR COMBI LAMP**



**CODE: G17228**

- Voltage: **10-30 V**
- 3 function rear stop/tail/indicator
- 108 LED
- Plastic base plate
- With fixing screws & wires
- ABS housing
- Polycarbonate lens

**LED FOG LAMP**



**CODE: G17225**

- Voltage: **10-30V**
- 36 SMD LED
- Polycarbonate lens
- Plastic base plate with fixing screws
- ABS housing

**CLEAR ROUND REFLECTOR**



**CODE: G2803**

**ALTERNATIVE OPTIONS AVAILABLE**

- Plastic housing
- 1 hole mounting

**LED REVERSING LAMP**

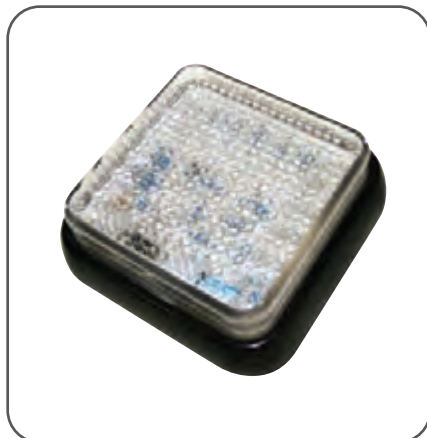

**CODE: G17227**

- Voltage: **10-30V**
- Plastic base plate with fixing screws
- With wires

**LED NUMBER PLATE LAMP WITH CABLE & STUDS**



**CODE: G17220**

- Voltage: **10-30V**
- 12 SMD LED
- Plastic base plate with fixing screws
- ABS housing
- Polycarbonate lens

**LED MUDGUARD MARKER LAMP**



**CODE: G17238**

- Voltage: **10-30V**
- Rubber casing
- Red / white lens

Our Additional Trailer Products includes relevant products from a variety of alternative sections that Genfitt can provide. Please visit [www.genfitt.ie](http://www.genfitt.ie) or ask your local representative for more details on any of our additional products included in this catalogue.

**LED 45° LEFT HAND MARKER LAMP**



CODE: **G17241**

**RIGHT HAND LAMP AVAILABLE**

- Voltage: **10-30V**
- 45° rubber casing
- Red / white lens

**LED VARIVOLT CLEAR FRONT LAMP FM20**



CODE: **G17216**

**MULTIPACK AVAILABLE**

- Voltage: **10-30V**
- Plastic base plate with fixing screws
- With wires

**LED VARIVOLT AMBER SIDE LAMP SM20**



CODE: **G17215**

**MULTIPACK AVAILABLE**

- Voltage: **10-30V**
- Plastic base plate with fixing screw
- With wires

**LED BOLT ON COMPACT FLEXIBLE BEACON**



CODE: **G18844**

- Voltage: DC **12-24V**
- LED Compact Flexible Bolt on Beacon
- Super Bright LED
- 120 Flashes per Minute
- Temperature range: -30°C to + 50°C
- Standards: ECE R65, ECE R10

**LED WARNING DOUBLE STROBE**



CODE: **G18109**

- Voltage: DC **12-24V**
- 6 LED double surface mount warning strobe
- 18W LED amber
- Five cables
- 9 flash patterns with memory function

**LED WARNING SURFACE STROBE**



CODE: **G18853**

- Voltage: DC **12-24V**
- 6 LED Slim Line Surface Mount Warning Strobe Light
- 18W LED: Amber
- Single / Double Flash
- Five cables

Our Additional Trailer Products includes relevant products from a variety of alternative sections that Genfitt can provide. Please visit [www.genfitt.ie](http://www.genfitt.ie) or ask your local representative for more details on any of our additional products included in this catalogue.

**LED WARNING ALUMINIUM STROBE**



CODE: **G18860**

- ALTERNATIVE COLOURS AVAILABLE**
- Voltage: **DC 12-24V**
  - 6 LED surface mount warning strobe
  - 18W LED: White
  - Five cables
  - 9 flash patterns with memory function

**7 PIN PVC PLUG**



CODE: **G2739**

- Voltage: **12V**
- Electrics: **7-pin**
- PVC casing

**7 PIN PVC SOCKET**



CODE: **G2735**

- Voltage: **12V**
- Electrics: **7-pin**
- PVC casing
- Screw connector

**BRITAX 10 WAY JUNCTION BOX**



CODE: **G18282**

- Britax 10-way junction box
- For 12v and 24v applications
- Spade terminals
- As fitted for IFOR Williams trailers

**WARNING ALARM**



CODE: **G18514**

- ALTERNATIVE OPTIONS AVAILABLE**
- DC 12-80V 102 dB
  - For use in construction machinery or other environments where noise pollution is frequent in order to alert individuals working in these areas of potential danger of moving machinery

**TOW PIN**



CODE: **G4099**

- ALTERNATIVE SIZES AVAILABLE**
- Size: **1in x 155mm**
  - Complete with chain
  - Finish: zinc plated
  - Material: EN8

Our Additional Trailer Products includes relevant products from a variety of alternative sections that Genfitt can provide. Please visit [www.genfitt.ie](http://www.genfitt.ie) or ask your local representative for more details on any of our additional products included in this catalogue.

ELECTRICAL & LIGHTING
  HYDRAULICS
  HARDWARE
  TRACTOR
  LIFTING EQUIPMENT & RATCHET TIE DOWNS

**AL-KO COMPACT  
BRAKED HAND WINCH 450**



**CODE: G18531**

**ALTERNATIVE OPTIONS AVAILABLE**

- Size: **450kg**
- Cable winch type 450 compact
- Braked without automatic unwinder
- Tensile load max. lowest cable position: 450 kg
- Manual force: 220 N

**ERGONOMIC  
RATCHET LASHING**



**CODE: G18979**

**ALTERNATIVE OPTIONS AVAILABLE**

- Capacity: **5T x 8m**
- Ratchet Lashing with 50mm or 75mm Webbing
- Complete with double J Hook end fitting

**RATCHET LASHING**



**CODE: G924**

**ALTERNATIVE SIZES AVAILABLE**

- Capacity: **1T x 4m**
- Easy to handle ratchet strap
- Complete with hook
- Meets EN 12195-2 standard

**LIFTING CHAIN GRADE 80**



**CODE: G978**

**ALTERNATIVE SIZES AVAILABLE**

- Material: high tensile steel grade 80
- Finish: black

**1 LEG TESTED SAFETY CHAIN**



**CODE: G17632**

- Capacity: **20T**
- Supplied complete with master link, hammer lock, black grade 80 lifting chain and bow shackle
- Finish: various material

**LIFTING HOOK WITH CLIP**



**CODE: G12859**

**ALTERNATIVE SIZES AVAILABLE**

- Capacity: **2T**
- Material: high tensile steel grade 80
- Finish: yellow painted

Our Additional Trailer Products includes relevant products from a variety of alternative sections that Genfitt can provide. Please visit [www.genfitt.ie](http://www.genfitt.ie) or ask your local representative for more details on any of our additional products included in this catalogue.

WELD ON LIFTING POINT



CODE: G19043

ALTERNATIVE SIZES AVAILABLE

- G80
- 1T 14mm
- Weld-on Lifting Point
- Designed with spring to stop at any angle

LIFTING HOOK WITH CLEVIS & LOCKING PIN



CODE: G19050

ALTERNATIVE SIZES AVAILABLE

- G80
- 40kN 8mm
- Clevis Grab Hook
- Suitable for use with Grade 8 chains and loadbinders

TESTED LOADBINDER



CODE: G19047

ALTERNATIVE SIZES AVAILABLE

- G80
- 40kN 8mm
- Ratchet loadbinder with winged grab hook and safety pin device
- Used for tensioning chain in lashing applications
- MBL equals 2 x lashing capacity

STAINLESS STEEL PULLEY WITH SWIVEL EYE



CODE: G19291

ALTERNATIVE SIZES AVAILABLE

- Size: 25mm
- Finish: stainless steel

ROLL OF GALVANISED WIRE ROPE

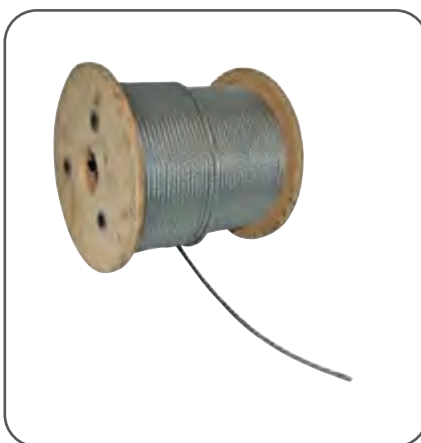

CODE: G878

ALTERNATIVE SIZES AVAILABLE

- Size: 3mm
- Finish: galvanized
- Supplied in rolls

ZINC PLATED SHACKLES



CODE: G773

ALTERNATIVE SIZES AVAILABLE

- Size: 3/16in - (5mm)
- Available sizes: 3/16in to 1in
- Finish: zinc plated

Our Additional Trailer Products includes relevant products from a variety of alternative sections that Genfitt can provide. Please visit [www.genfitt.ie](http://www.genfitt.ie) or ask your local representative for more details on any of our additional products included in this catalogue.

ELECTRICAL & LIGHTING    HYDRAULICS    HARDWARE    TRACTOR    LIFTING EQUIPMENT & RATCHET TIE DOWNS

**R2AT HYDRAULIC HOSE**



**CODE: G2069**

**ALTERNATIVE SIZES AVAILABLE**

- Capacity: **1/4in (Metre) WP5800**
- Available sizes: **1/4in to 1.1/2in**
- Supplied in coils
- Order hose per metre
- Standard: EN853 / EN856 / EN857 2SN

**SPIRAL GUARD COVER**



**CODE: G18765**

**ALTERNATIVE SIZES AVAILABLE**

- Size: **16mm id x 50m**
- Flame retardant anti-static spiral guard
- Standard hosing spiral guard protection
- Material: black HDPE

**ANTI BURST HOSE SLEEVE**



**CODE: G18774**

**ALTERNATIVE SIZES AVAILABLE**

- Size: **20mm id x 25m**
- Abrasion protection for hydraulic hosing to protect people operating near by hydraulic hoses in cases of pin hole leaks

**BSP 2 PIECE SWAGE FEMALE INSERT**



**CODE: G13139**

**ALTERNATIVE SIZES AVAILABLE**

- Size: **1/4in**
- Seat: **60°**

**BURST VALVE**



**CODE: G18211**

**ALTERNATIVE SIZES AVAILABLE**

- Size: **1/2in x 1/2in**
- Female x Female
- Hydraulic safety device valves
- Used to prevent uncontrolled descent of a load in case of hose failure

**INLINE SAFETY CHECK MALE VALVE**



**CODE: G18613**

**ALTERNATIVE SIZES AVAILABLE**

- Size: **1/4in BSP**
- Dynamic check valve provides leak free closure in one direction and free flow in the other
- Heavy duty carbon steel body

Our Additional Trailer Products includes relevant products from a variety of alternative sections that Genfitt can provide. Please visit [www.genfitt.ie](http://www.genfitt.ie) or ask your local representative for more details on any of our additional products included in this catalogue.

**STANDARD DUTY DOUBLE ACTING HYDRAULIC RAM**



**CODE: G3895**

**ALTERNATIVE SIZES AVAILABLE**

- Size: 12in x 60id x 40mm
- Working pressure: 180 Bar - 2,610 PSI
- Max pressure: 250 Bar - 3,625 PSI
- Ports: 3/8in BSP
- Finish: self colour

**HEAVY DUTY DOUBLE ACTING HYDRAULIC RAM**



**CODE: G12193**

**ALTERNATIVE SIZES AVAILABLE**

- Size: 24in x 90id x 50mm
- Working pressure: 180 Bar - 2,610 PSI
- Stroke: 410mm
- Ports: 3/8in BSP
- Finish: Self colour

**4 STAGE HEAVY DUTY TRAILER RAM**



**CODE: G18219**

**ALTERNATIVE SIZES AVAILABLE**

- RAM 4 STAGE x 49in H/D CHROMED
- Low speed for agricultural use
- Suitable for all trailer manufactures
- Low speed for agricultural use
- Suitable for all trailer manufactures

**TRAILER BRAKING RAM**



**CODE: G17202**

**ALTERNATIVE SIZES AVAILABLE**

- Size: 25m
- Working pressure: 180 Bar - 2,610 PSI
- Max pressure: 250 Bar - 3,625 PSI
- Ports: 3/8in BSP

**INTERNAL SPRING BRAKE RAM**



**CODE: G3938**

**ALTERNATIVE SIZES AVAILABLE**

- Size: 8in
- Working pressure: 180 Bar - 2,610 PSI
- Max pressure: 250 Bar - 3,625 PSI
- Ports: 3/8in BSP

**TRAILER BRAKE SINGLE SPRING RAM ASSEMBLY**



**CODE: G3939**

**ALTERNATIVE SIZES AVAILABLE**

- Size: 8in
- Working pressure: 180 Bar - 2,610 PSI
- Max pressure: 220 Bar - 3,625 PSI
- Ports: 3/8in BSP

Our Additional Trailer Products includes relevant products from a variety of alternative sections that Genfitt can provide. Please visit [www.genfitt.ie](http://www.genfitt.ie) or ask your local representative for more details on any of our additional products included in this catalogue.

- ELECTRICAL & LIGHTING
- HYDRAULICS
- HARDWARE
- TRACTOR
- LIFTING EQUIPMENT & RATCHET TIE DOWNS



**HYDRAULIC FLOW  
REGULATOR CHECK VALVE**



**CODE: G18602**

**ALTERNATIVE SIZES AVAILABLE**

- Size: **1/4in BSP**
- Flow Regulator Check Valves are used to adjust the speed of cylinders in one direction and allows free return in the opposite direction

**HYDRAULIC BALL VALVE**



**CODE: G3773A**

**ALTERNATIVE SIZES AVAILABLE**

- Size: **1/4in 500 Bar**
- High quality one piece shut-off valve
- Carbon steel
- Suitable for rigid pipe or flexible hose connection

**HYDRAULIC PRESSURE GAUGE**



**CODE: G19409**

**ALTERNATIVE SIZES AVAILABLE**

- PSI: **150PSI**
- Diameter: 63mm face
- Port: 1/4in BSP male
- Bottom connection

**DOUBLE ACTING  
HYDRAULIC HAND PUMP**



**CODE: G3953**

- Including 5L Tank
- Suitable for medium pressure and large stroke volume
- Tank capacity: 5 litre
- Working pressure: 42,50 PSI

**12V DOUBLE ACTING POWER  
PACK WITH REMOTE & 7L TANK**



**CODE: G17787**

- Including 7.5L Tank
- Voltage: **12V**
- Wired remote control included
- Suitable for use on remote tanks and bowsers

**12V SINGLE ACTING POWER  
PACK WITH REMOTE & 7L TANK**



**CODE: G17788**

- Including 7.5L Tank
- Voltage: **12V**
- Wired remote control included
- Suitable for use on remote tanks and bowsers

Our Additional Trailer Products includes relevant products from a variety of alternative sections that Genfitt can provide. Please visit [www.genfitt.ie](http://www.genfitt.ie) or ask your local representative for more details on any of our additional products included in this catalogue.

# WHEEL SUITABILITY MATRIX













TRAILER

		PRODUCT IMAGE									
		CODE	G8729	G8730	G18490	G19469	G19470	G19472	G19473	G19474	G19475
PRODUCT IMAGE	CODE	DESCRIPTION	WHEEL 4-STUD 18 X 9.5 X 8 MUD SAND 98MM PCD	WHEEL 4-STUD 22 X 11.0 X 8 4IN PCD	WHEEL 4-STUD 22 X 11.0 X 8 4PLY 100MM PCD	WHEEL 4-STUD 4PLY 20.5X8-10 HIGH SPEED 100MM PCD	WHEEL 4-STUD 4PLY 20.5X8-10 HIGH SPEED 100MM PCD	WHEEL 4-STUD 500 X 10 4PLY 100MM PCD	WHEEL 4-STUD 145 R10 4PLY 4IN PCD	WHEEL 4-STUD 145 R10 4PLY 100MM PCD	WHEEL 4-STUD 145 R10 8PLY 5.5IN PCD
	G13552	HUB A/R FIAT & CABLE RH 98MM PCD									
	G3082	HUB A/R FIAT & CABLE LH 98MM PCD									
	G13553	HUB A/R FORD & CABLE 1000KG RH 4.1/4IN PCD									
	G3183	HUB A/R FORD & CABLE 1000KG LH 4.1/4IN PCD									
	G13554	HUB A/R HIACE & CABLE 1000KG RH 4.5IN PCD									
	G3184	HUB A/R HIACE & CABLE 1000KG LH 4.5IN PCD									
	G13555	HUB A/R LROV & CABLE 1500KG RH 6.5IN PCD									
	G3185	HUB A/R LROV & CABLE 1500KG LH 6.5IN PCD									
	G13556	HUB A/R LROV & CABLE 1800KG RH 6.5IN PCD									
	G3186	HUB A/R LROV & CABLE 1800KG RH 6.5IN PCD									
	G13259	AXLE SOLID FIAT U/B 1000KG 98MM PCD									
	G13258	AXLE SOLID FIAT BRK 1000KG 98MM PCD									
	G13260	AXLE SOLID L/R BRK 74IN 1500KG 165.1MM PCD									
	G13261	AXLE SOLID L/R BRK 80IN 1500KG 165.1MM PCD									
	G13257	AXLE SUSP. FIAT U/B 1000KG 98MM PCD									
	G14400	SUSP. FIAT U/B 375KG L/H 98MM PCD									
	G14401	SUSP. FIAT U/B 375KG R/H 98MM PCD									
	G14409	SUSP. FIAT BRK 375KG L/H 98MM PCD									
	G14410	SUSP. FIAT BRK 375KG R/H 98MM PCD									
	G19519	SUSP. SET 500KG UB 4-STUD 4IN PCD									
	G19520	SUSP. SET 750KG UB 4-STUD 100MM PCD									



# WHEEL SUITABILITY MATRIX













		PRODUCT IMAGE									
		CODE	G8729	G8730	G18490	G19469	G19470	G19472	G19473	G19474	G19475
PRODUCT IMAGE	CODE	DESCRIPTION	WHEEL 4-STUD 18 X 9.5 X 8 MUD SAND 98MM PCD	WHEEL 4-STUD 22 X 11.0 X 8 4IN PCD	WHEEL 4-STUD 22 X 11.0 X 8 4PLY 100MM PCD	WHEEL 4-STUD 4PLY 20.5X8-10 HIGH SPEED 100MM PCD	WHEEL 4-STUD 4PLY 20.5X8-10 HIGH SPEED 100MM PCD	WHEEL 4-STUD 500 X 10 4PLY 100MM PCD	WHEEL 4-STUD 145 R10 4PLY 4IN PCD	WHEEL 4-STUD 145 R10 4PLY 100MM PCD	WHEEL 4-STUD 145 R10 8PLY 5.5IN PCD
	G19521	SUSPENSION AXLE 750KG UB 4-STUD 100MM PCD					✓	✓		✓	
	G19522	HUB 6IN A/R BR STUB SET 900KG 4-STUD 100MM PCD					✓			✓	
	G19523	HUB 6IN A/R BR STUB SET 900KG 5-STUD 112MM PCD									
	G19524	HUB 8IN A/R BR STUB SET 1500KG 4-STUD 100MM PCD					✓	✓		✓	
	G19525	HUB 8IN A/R BR STUB SET 1500KG 4-STUD 5.5IN PCD									✓
	G19526	HUB 8IN A/R BR STUB SET 1500KG 5-STUD 112MM PCD									
	G19527	HUB 8IN A/R BR STUB SET 1500KG 4-STUD 108MM PCD									
	G19528	HUB 8IN A/R BR STUB SET 1500KG 4-STUD 115MM PCD									
	G19529	HUB 8IN A/R BR STUB SET 1500KG 5-STUD 115MM PCD									
	G19543	HUB 4-STUD 100MM UB HIGH SPEED			✓	✓	✓	✓		✓	
	G3078	HUB FORD UNBRAKED 4.1/4IN PCD									
	G3079	HUB LANDROVER UNBRAKED 6.5IN PCD									
	G3080	HUB FIAT UNBRAKED (MAX 40KM/H) 98MM PCD	✓								
	G3081	HUB FIAT UNBRAKED HIGH- SPEED 98MM PCD									
	G3083	HUB FIAT BRAKED (MAX 40KM/H) 98MM PCD									

												
G19477	G19478	G19492	G3094	G3095	G3096	G3097	G19476	G19479	G19480	G16537	G3098	G3100N
WHEEL 4-STUD 155/80 R13 4PLY 100MM PCD	WHEEL 4-STUD 165/80 R13 8PLY 5.5IN PCD	WHEEL 4-STUD 400 X 8 X 4PR 100MMPCD	WHEEL 4-STUD 400 X 8 4PLY 4IN PCD	WHEEL 4-STUD BOAT 520 X 10 X 4PLY 4IN PCD	WHEEL 4-STUD FIAT 165 X70 X13 98MM PCD	WHEEL 4-STUD FIAT 175 X70 X14 98MM PCD	WHEEL 5-STUD 185/60 R12 165.1MM PCD	WHEEL 5-STUD 185 R14 8PLY 112MMPCD	WHEEL 5-STUD 6.50 R16 10PLY 165.1MM PCD	WHEEL 5 STUD L/RVR 155/70/12 6.5IN PCD	WHEEL 5-STUD L/RVR 195/50/13 6.5IN PCD	WHEEL 5-STUD L/RVR 185/70/13 6.5IN PCD
✓		✓										
✓												
								✓				
✓		✓										
	✓											
								✓				
✓		✓										
							✓		✓	✓	✓	✓
					✓	✓						
					✓	✓						
					✓	✓						

# WHEEL SUITABILITY MATRIX

TRAILER

		PRODUCT IMAGE									
		CODE	G8729	G8730	G18490	G19469	G19470	G19472	G19473	G19474	G19475
PRODUCT IMAGE	CODE	DESCRIPTION	WHEEL 4-STUD 18 X 9.5 X 8 MUD SAND 98MM PCD	WHEEL 4-STUD 22 X 11.0 X 8 4IN PCD	WHEEL 4-STUD 22 X 11.0 X 8 4PLY 100MM PCD	WHEEL 4-STUD 4PLY 20.5X8-10 HIGH SPEED 100MM PCD	WHEEL 4-STUD 4PLY 20.5X8-10 HIGH SPEED 100MM PCD	WHEEL 4-STUD 500 X 10 4PLY 100MM PCD	WHEEL 4-STUD 145 R10 4PLY 4IN PCD	WHEEL 4-STUD 145 R10 4PLY 100MM PCD	WHEEL 4-STUD 145 R10 8PLY 5.5IN PCD
	G3182	HUB HIACE UNBRAKED 5 STUD 4.5IN PCD									
	G3077	HUB MINI UNBRAKED 4 STUD 4IN PCD		✓					✓		
	G3086C	STUB FOR MINI U/B SUSP AXLE		✓					✓		
	G3087	SUSPENSION MINI 175KG L/H 4IN PCD							✓		
	G3088	SUSPENSION MINI 175KG R/H 4IN PCD							✓		
	G3090	SUSPENSION MINI 250KG L/H 4IN PCD							✓		
	G3091	SUSPENSION MINI 250KG R/H 4IN PCD							✓		
	G19481	RIM 8IN 4-STUD 4IN PCD 2.5 X 8									
	G19482	RIM 10IN 4-STUD 4IN PCD 3.5 X 10							✓		
	G19483	RIM 10IN 4-STUD 100MM PCD 3.5 X 10						✓		✓	
	G19484	RIM 12IN 5-STUD 165.1MM PCD (NARROW RIM) 4.5 J12									
	G19485	RIM 13IN 4-STUD 5.5IN PCD 4.5 J13									
	G19486	RIM 13IN 5-STUD 165.1MM PCD 6 J13									
	G19487	RIM 14IN 5-STUD 112MM PCD 5.5 J14									
	G19488	RIM 16IN 5-STUD 165.1MM PCD 5 J16									
	G19489	RIM 12IN 5-STUD 165.1MM PCD (WIDE RIM) 5.5 J12									

												
G19477	G19478	G19492	G3094	G3095	G3096	G3097	G19476	G19479	G19480	G16537	G3098	G3100N
WHEEL 4-STUD 155/80 R13 4PLY 100MM PCD	WHEEL 4-STUD 165/80 R13 8PLY 5.5IN PCD	WHEEL 4-STUD 400 X 8 X 4PR 100MM PCD	WHEEL 4-STUD 400 X 8 4PLY 4IN PCD	WHEEL 4-STUD BOAT 520 X 10 X 4PLY 4IN PCD	WHEEL 4-STUD FIAT 165 X70 X13 98MM PCD	WHEEL 4-STUD FIAT 175 X70 X14 98MM PCD	WHEEL 5-STUD 185/60 R12 165.1MM PCD	WHEEL 5-STUD 185 R14 8PLY 112MM PCD	WHEEL 5-STUD 6.50 R16 10PLY 165.1MM PCD	WHEEL 5 STUD L/RVR 155/70/12 6.5IN PCD	WHEEL 5-STUD L/RVR 195/50/13 6.5IN PCD	WHEEL 5-STUD L/RVR 185/70/13 6.5IN PCD
			✓	✓								
			✓	✓								
			✓	✓								
			✓	✓								
			✓	✓								
			✓	✓								
			✓									
				✓								
										✓		
	✓											
											✓	✓
								✓				
									✓			
							✓					



**HIGH PERFORMANCE**

[www.genfitt.ie](http://www.genfitt.ie)

**ONLINE PORTAL**

Everything Genfitt has to offer at your finger tips

**DO YOU WANT TO KNOW ABOUT OUR NEW PRODUCTS?**  
Our website is continuously launching and updating new products.

**DO YOU HAVE A TECHNICAL QUESTION?**  
You can use our website to access product images, diagrams & additional technical specifications.

**DO YOU HAVE A QUERY ON YOUR ACCOUNT?**  
By simply logging into your account you can download your invoices, credit notes etc.

**DO YOU WANT TO KNOW ABOUT OUR NEW PROMOTIONS?**  
Keep updated on our weekly & monthly online promotions.



JUST A FEW MORE FEATURES



24/7 ONLINE ACCESS



QUICK & EASY LOGIN



ONLINE CHAT



BOAT TRAILER DIAGRAM

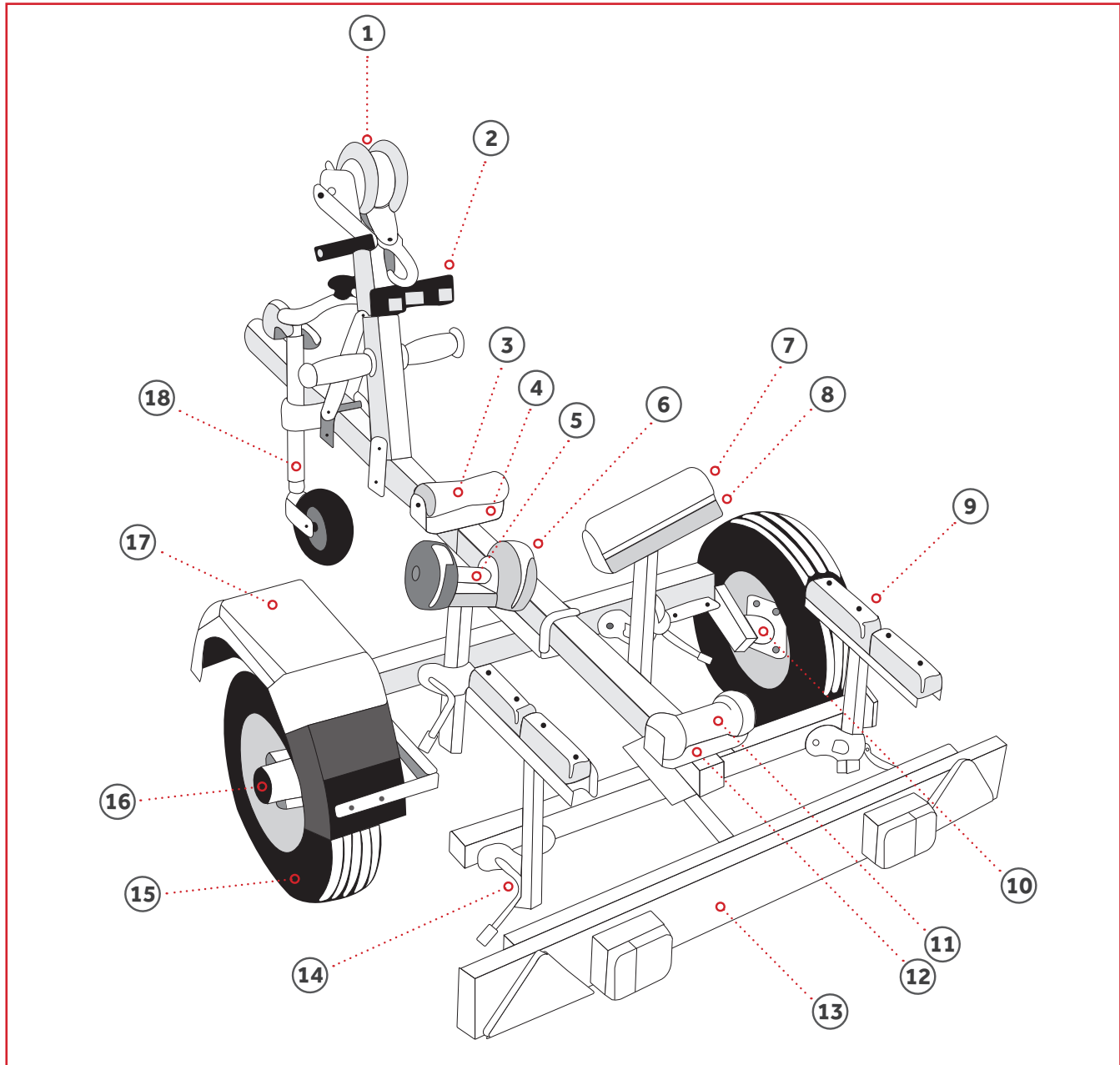

NO.	CODE	DESCRIPTION	NO.	CODE	DESCRIPTION
1	G15109	HAND WINCH W/ STRAP 600LB	11	G3119	KEEL ROLLER 127x16x51-70mm
1	G12116	HAND WINCH W/ STRAP 1000LB	12	G3118	KEEL ROLLER BRACKET 127mm
2	G3133	BOAT TRAILER BLOCK 152x38x44mm	13	G17751	LED TRAILER LIGHTING BOARD
3	G3120	V-KEEL ROLLER	13	G2749	LIGHTING BOARD
4	G3118	KEEL BRACKET ROLLER 127mm	14	G3126	HEAVY DUTY CLAMP 34mm
5	G3115	SINGLE SIDE ROLLER 64x16x102mm	15	G3090	MINI SUSPENSION UNIT 250kg
6	G3114	SINGLE SIDE ASSEMBLY ROLLER	15	G3087	MINI SUSPENSION UNIT 175kg
7	G3122	PARALLEL SIDE ROLLER 203x16x57mm	16	G3094	MINI 4 STUD WHEEL ASSEMBLY 400x8x4PR
8	G3121	SIDE ROLLER BRACKET W/ TUBE	16	G3095	MINI 4 STUD WHEEL ASSEMBLY 520x10x4PR
9	G3131	BOAT TRAILER BLOCK 305x38x19mm	17	G3167	SINGLE PVC MUDGUARD 490x140x195mm
10	G3088	MINI SUSPENSION UNIT 750kg	17	G3168	SINGLE PVC MUDGUARD 620x180x240mm
10	G3091	MINI SUSPENSION UNIT 250kg	18	G3062	FC242 JOCKEY WHEEL COMPLETE

**CATTLE TRAILER FRONT VIEW**  
(GUIDE ONLY)

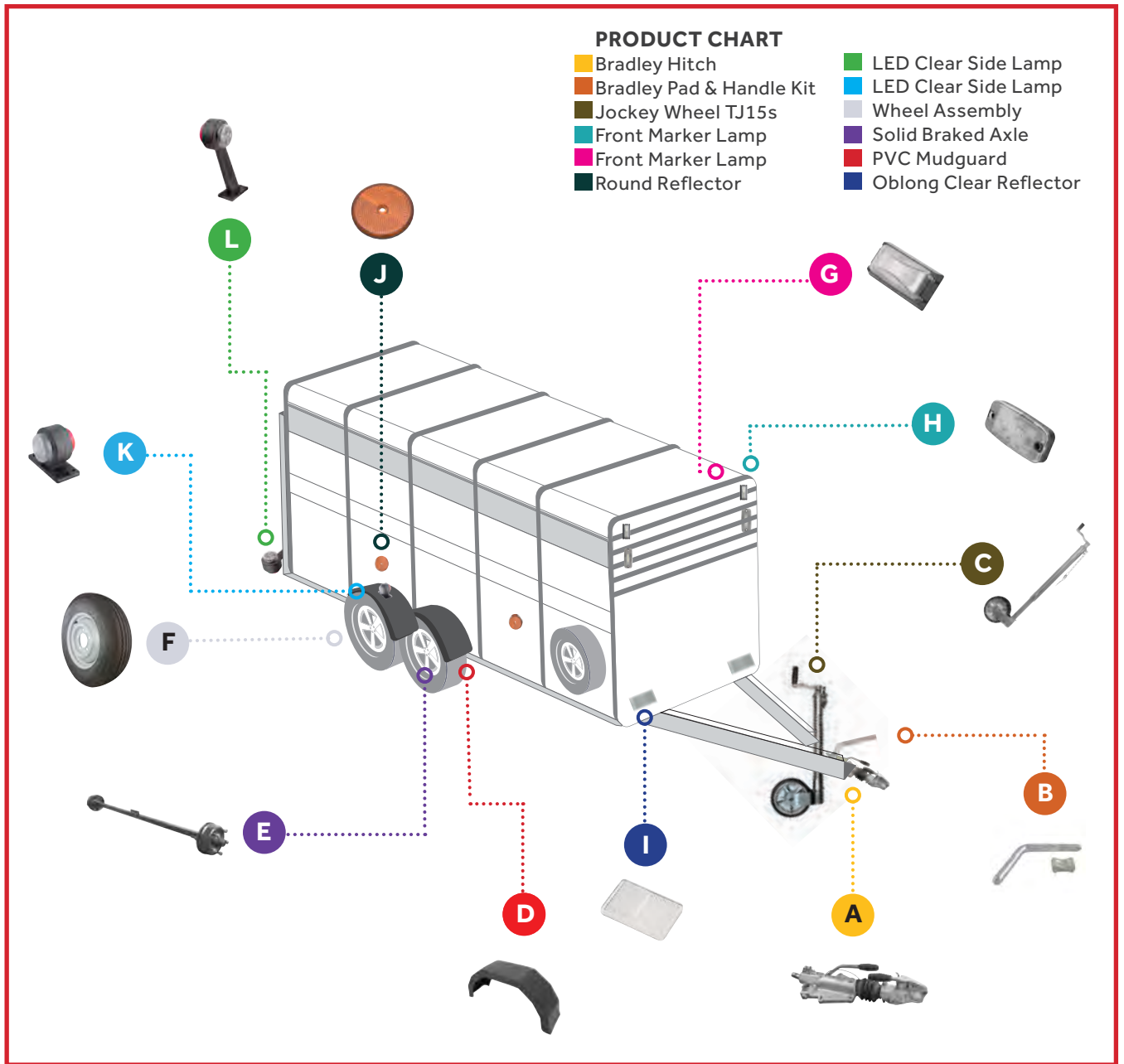

**PRODUCT COLOUR CODE CHART**

<b>A</b>	<b>G3042C</b>	Bradley Hitch	<b>G</b>	<b>G17692</b>	LED Front Marker Lamp
<b>B</b>	<b>G13972</b>	Bradley Pad & Handle Kit	<b>H</b>	<b>G17216</b>	LED Front Lamp
<b>C</b>	<b>G3059</b>	Jockey Wheel TJ15S	<b>I</b>	<b>G2804</b>	Oblong Reflector
<b>D</b>	<b>G3168A</b>	PVC Mudguard	<b>J</b>	<b>G12430</b>	Round Reflector (Amber)
<b>E</b>	<b>G13260</b>	Solid Braked Axle	<b>K</b>	<b>G17238</b>	LED Side Marker Lamp
<b>F</b>	<b>G19480</b>	Wheel Assembly	<b>L</b>	<b>G17242</b>	Front Marker Lamp

**CATTLE TRAILER REAR VIEW**  
(GUIDE ONLY)

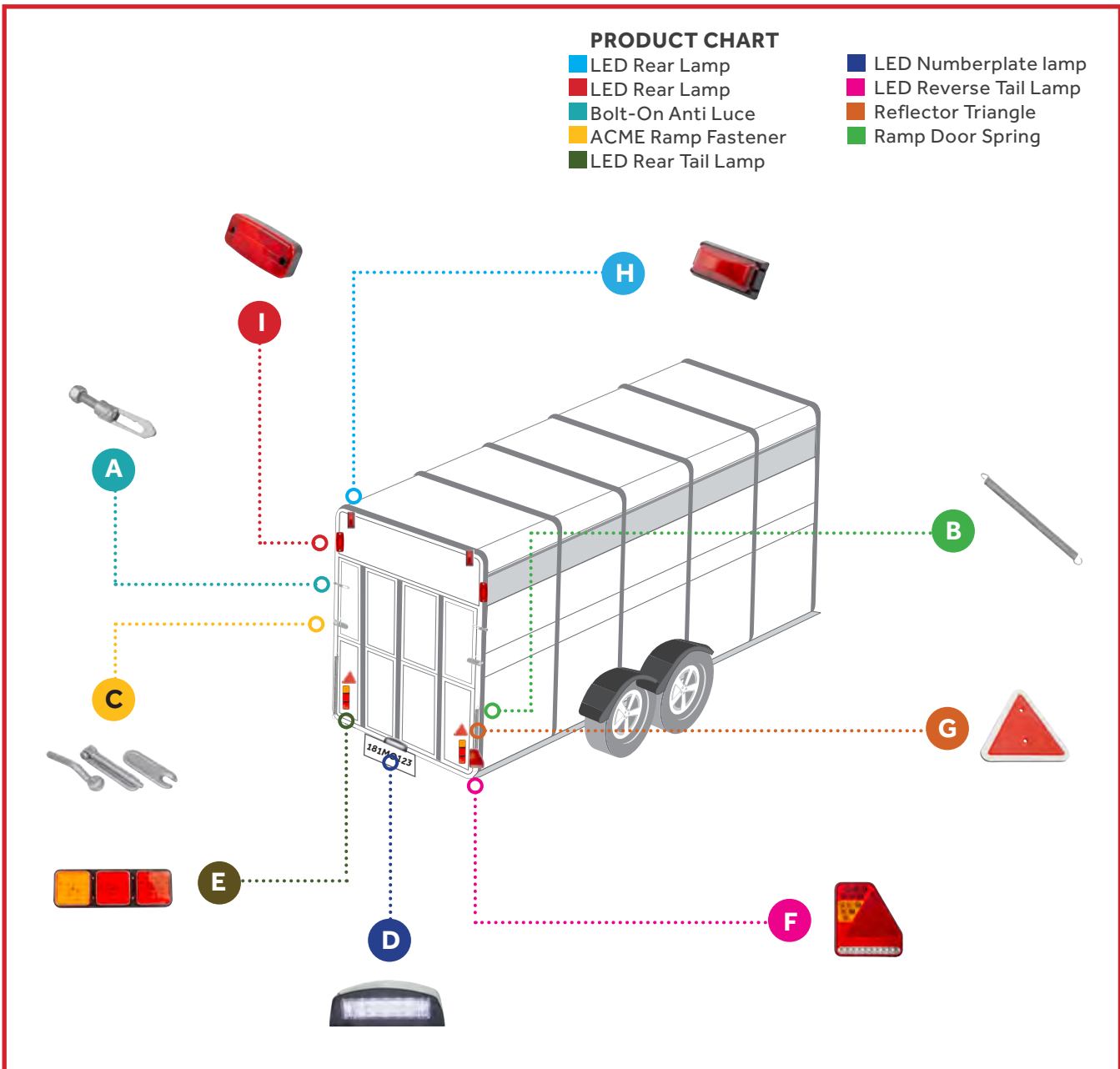

**PRODUCT COLOUR CODE CHART**

<b>A</b>	<b>G2915</b>	Bolt-on Anti Luce	<b>D</b>	<b>G17220</b>	Numberplate Lamp
<b>B</b>	<b>G2941</b>	Ramp Door Spring	<b>E</b>	<b>G17229</b>	LED Rear Tail Lamp
<b>C</b>	<b>G3136</b>	ACME Ramp Fastener	<b>F</b>	<b>G18071</b>	LED Rear Tail Lamp
			<b>G</b>	<b>G2743</b>	Reflector Triangle with Backing
			<b>H</b>	<b>G17691</b>	LED Red Rear Lamp
			<b>I</b>	<b>G17217</b>	LED Red Rear Lamp

**DUMP TRAILER REAR VIEW**  
(GUIDE ONLY)

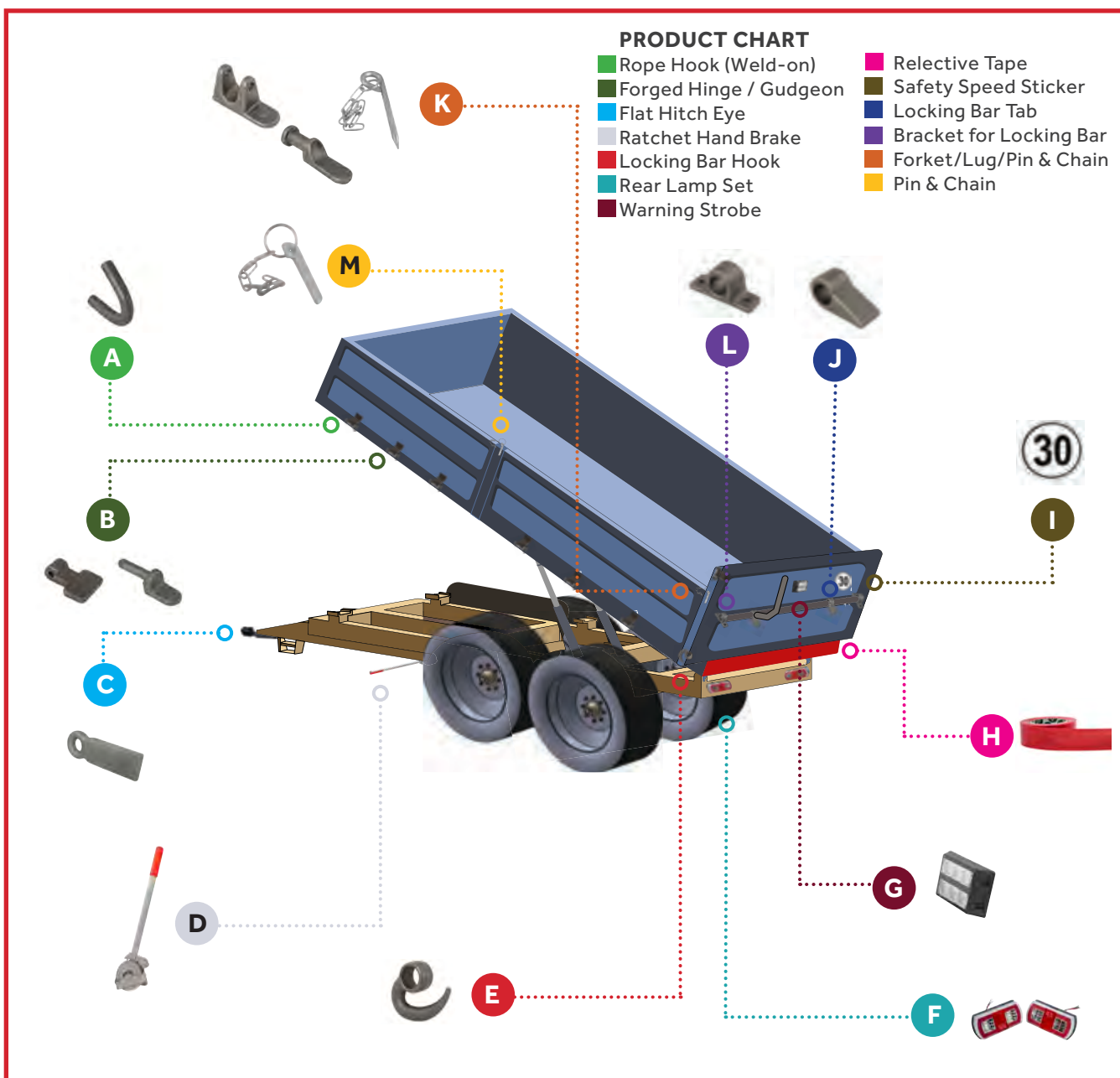

**PRODUCT COLOUR CODE CHART**

<b>A</b>	<b>G2994A</b>	Weld-on C-Type Rope Hook	<b>H</b>	<b>G16920</b>	Rigid Reflective Tape
<b>B</b>	<b>G2992</b>	Forged Hinge	<b>I</b>	<b>G18214</b>	Vehicle Safety Speed Sticker
<b>B</b>	<b>G2923</b>	Weld-on Gudgeon	<b>J</b>	<b>G3001A</b>	Locking Bar Tab
<b>C</b>	<b>G2951C</b>	Flat Hitch Eye	<b>K</b>	<b>G2955</b>	Forket With Plate
<b>D</b>	<b>G19183</b>	Ratchet Hand Brake (Trailer)	<b>K</b>	<b>G2956</b>	Trailer Lug
<b>E</b>	<b>G3002A</b>	Locking Bar Hook	<b>K</b>	<b>G2954</b>	Round Pin & Chain
<b>F</b>	<b>G18527</b>	Rear Lamp Set (3 Function)	<b>L</b>	<b>G3003A</b>	Bracket For Locking Bar
<b>G</b>	<b>G18109</b>	LED Warning Strobe	<b>M</b>	<b>G2918</b>	Pin & Chain

**DUMP TRAILER FRONT VIEW**  
(GUIDE ONLY)

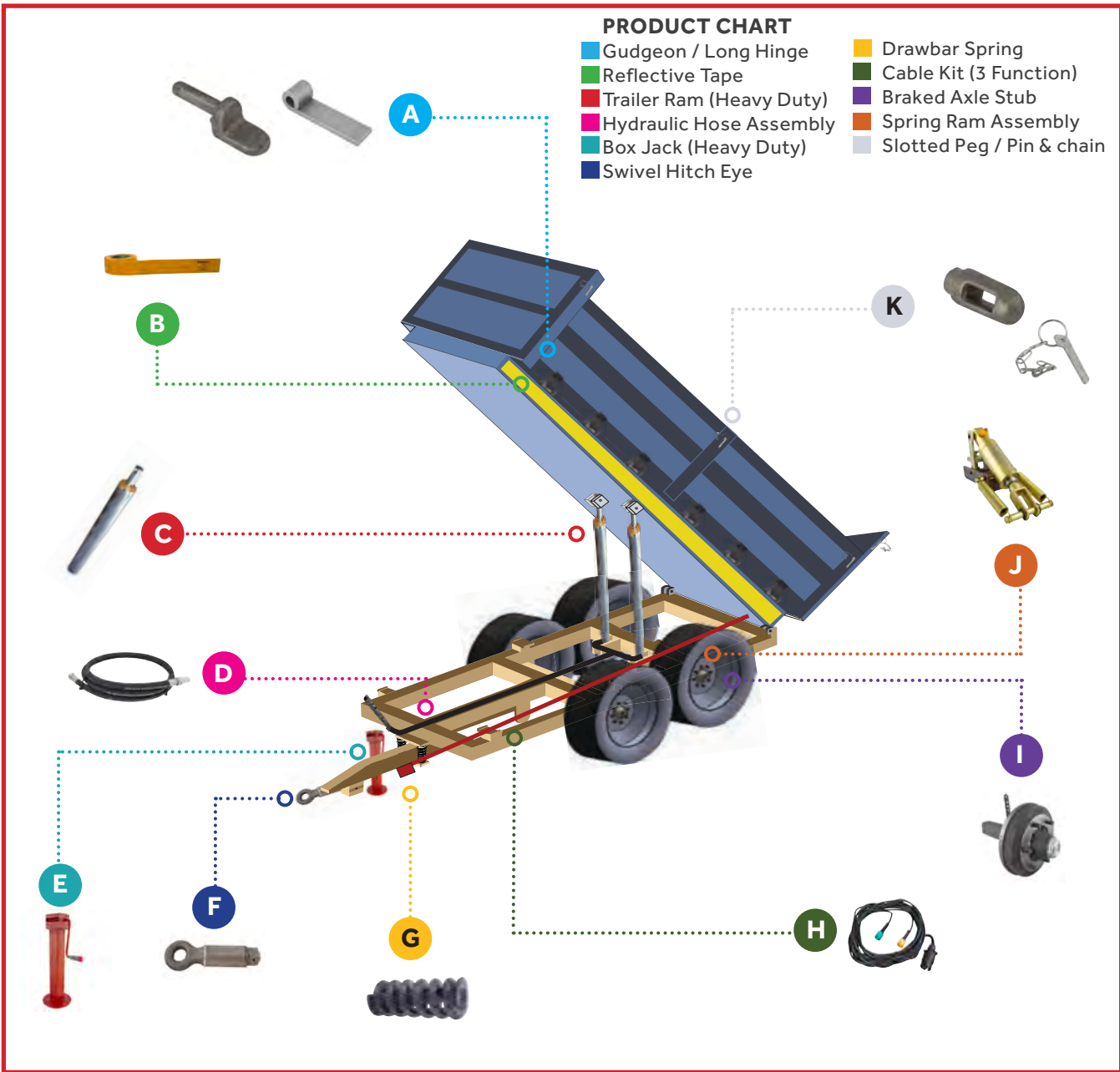

**PRODUCT COLOUR CODE CHART**

<b>A</b>	<b>G2923</b>	Weld-on Gudgeon	<b>G</b>	<b>G8935A</b>	Drawbar Spring
<b>A</b>	<b>G2930</b>	Straight Long Hinge	<b>H</b>	<b>G18580</b>	Cable Assembly Kit
<b>B</b>	<b>G16919</b>	Rigid Reflective Tape	<b>I</b>	<b>G11053</b>	Braked Axle Stub
<b>C</b>	<b>G18219</b>	Trailer Ram (Heavy Duty)	<b>J</b>	<b>G17205</b>	Spring Ram Assembly
<b>D</b>	<b>N/A</b>	Hydraulic hose Assembly	<b>K</b>	<b>G2920</b>	Slotted Peg
<b>E</b>	<b>G18447</b>	Side Winding Box Jack	<b>K</b>	<b>G2918</b>	Pin & Chain
<b>F</b>	<b>G12747</b>	Swivel Hitch Eye			

<b>ACME</b>			
ACME Ramp Fastener.....	80	Fiat High Speed Solid Braked Axle.....	55
<b>Actuator</b>		Fiat High Speed Solid Unbraked Axle.....	54
Air/Hydraulic Actuator.....	36	Fiat Unbraked Suspension Axle.....	57
<b>Adaptor</b>		Land Rover 1500kg High Speed Solid Braked Axle.....	55
Air Brake Adaptor.....	39	Land Rover Braked Suspension Axle.....	56
Inner Air Brake Adaptor.....	39	Unbraked Mini Axle Stub.....	47
Stepped Bulkhead Air Brake Adaptor.....	40	<b>Beacon</b>	
Straight Bulkhead Air Brake Adaptor.....	40	LED Bolt On Compact Flexible Beacon.....	89
<b>Air Brake</b>		<b>Bearing</b>	
Air Brake 4 Way Valve.....	44	Wheel Bearing Kit SB005.....	64
Air Brake Adaptor.....	39	<b>Bellows</b>	
Air Brake Coil Handles.....	39	Bradley 107 Bellows Service Kit.....	8
Air Brake Coupling C-Type Female.....	44	Bradley 2039 Bellows Service Kit.....	8
Air Brake Coupling C-Type Male.....	43	Avonride Black Hitch Bellows.....	14
Air Brake Drain Valve.....	42	Avonride/Knott 3500kg Coupling Bellows.....	14
Air Brake Drain Valve With Cable.....	43	Avonride Red Hitch Bellows.....	13
Air Brake Flexi Coil.....	38	<b>Block</b>	
Air Brake Hose.....	38	2-Hole Boat Trailer Block.....	85
Air Brake O-Ring.....	43	4-Hole Boat Trailer Block.....	85
Air Brake Plug Fitting.....	42	Boat Trailer Block.....	85
Air Brake Reusable Fittings.....	41	Towball Spacer Block.....	23
Air Brake Reusable Fittings 90°.....	42	<b>Boat</b>	
Air Brake Stud Fittings.....	40	2-Hole Boat Trailer Block.....	85
Air Brake Stud Fittings 90°.....	41	4-Hole Boat Trailer Block.....	85
Air Brake Test Point.....	43	Boat Trailer 4-Stud Wheel Assembly.....	67
Air Brake Thrust Ring.....	43	Boat Trailer Block.....	85
Air/Hydraulic Actuator.....	36	Boat Trailer Hull Support Pad.....	85
Anti-kink Air Brake Flexi Coil.....	38	<b>Box</b>	
End Mounted Air Brake Reservoir.....	37	Heavy Duty Side Winding Box Jack.....	31
Inner Air Brake Adaptor.....	39	Hydraulic Box Jack.....	31
Palm Type Air Brake Coupling.....	44	BRITAX 10 Way Junction Box.....	90
Stepped Bulkhead Air Brake Adaptor.....	40	Catch Box Pin.....	73
Strap Mounted Air Brake Reservoir.....	37	Side Winding Box Jack.....	31
Straight Bulkhead Air Brake Adaptor.....	40	Side Winding Round Box Jack.....	32
<b>Alarm</b>		Top Winding Box Jack.....	31
Warning Alarm.....	90	Top Winding Round Box Jack.....	32
<b>AL-KO</b>		<b>Bracket</b>	
AL-KO 4-Stud 100mm Unbraked High Speed		Bracket Channel.....	84
Stub Axle Complete.....	45	Bracket for Locking Bar.....	80
AL-KO AK7 750kg Coupling Head.....	2	Brake Cable Bracket.....	35
AL-KO Compact Braked Hand Winch 450.....	91	FC242 Bracket - 48MM.....	29
AL-KO Detachable Braking Cable.....	34	Keel Roller Bracket.....	84
AL-KO Style Auto Reverse Axle Brake Shoe Sets.....	33	Leaf Spring Bracket.....	60
AL-KO Unbraked Suspension Axle.....	57	Side Roller Bracket With Tube.....	84
Auto Reverse 4 Stud 5.5inch PCD Hub Set 1500kg.....	51	TJ11 Jockey Wheel Bracket - 35MM.....	29
Auto Reverse 4 Stud 100mm PCD Hub Set 900kg.....	50	TJ12 Jockey Wheel Bracket - 42MM.....	29
Auto Reverse 4 Stud 108mm PCD Hub Set 1500kg.....	51	TJ15 Jockey Wheel Bracket - 48MM.....	29
Auto Reverse 4 Stud 115mm PCD Hub Set 1500kg.....	52	<b>Bradley</b>	
Auto Reverse 5 Stud 112mm PCD Hub Set 900kg.....	52	Bradley 107 Bellows Service Kit.....	8
Auto Reverse 5 Stud 112mm PCD Hub Set 1500kg.....	53	Bradley 255 Damper Kit.....	6
Auto Reverse 5 Stud 115mm PCD Hub Set 1500kg.....	53	Bradley 259 Damper Kit.....	6
<b>Anti Luce</b>		Bradley 260 Damper Kit.....	7
Anti-Luce Plate.....	75	Bradley 2039 Bellows Service Kit.....	8
Bolt-On Anti-Luce.....	74	Bradley 3220 Damper Kit.....	7
Bolt-On Baby Anti-Luce.....	74	Bradley Breakaway Cable Kit.....	8
Weld-On Anti-Luce.....	74	Bradley D30 Spring Damped Hitch.....	2
Weld-On Baby Anti-Luce.....	74	Bradley D40 Spring Damped Hitch.....	3
<b>ATV</b>		Bradley D60 Spring Damped Hitch.....	3
ATV Hub Grease Cap.....	62	Bradley D201 Unbraked Hitch.....	2
ATV Trailer Kit.....	70	Bradley E40TC Towing Jaw 3.5 Ton.....	19
<b>Axle</b>		Bradley E100TC Towing Jaw 3.5 Ton.....	19
6-Stud 400mm Unbraked Stub Axle Complete.....	45	Bradley HU3 2000kg Hydratow Delta Hitch.....	3
6 Stud 1750mm Braked Axle Complete.....	54	Bradley HU3 2700kg Hydratow Delta Hitch.....	4
6 Stud Braked Stub Axle Complete.....	48	Bradley HU3 Coupling Head Kit.....	5
AL-KO 4-Stud 100mm Unbraked High Speed		Bradley HU12 3500kg Hydratow Delta Hitch.....	4
Stub Axle Complete.....	45	Bradley HU12 Coupling Head Kit.....	5
AL-KO Style Auto Reverse Axle Brake Shoe Sets.....	33	Bradley Lock-it.....	8
AL-KO Unbraked Suspension Axle.....	57	Bradley Pad 3349 & Handle Kit.....	6
Auto Reverse Axle Brake Shoe Sets.....	33	Bradley Pad 3350 & Handle Kit.....	5
Axle Grease Cap.....	64	Bradley Trigger Spring.....	6
Axle Grease Cap For Fiat Hub.....	64	<b>Brake</b>	
Axle Nut.....	71	6 Stud 1750mm Braked Axle Complete.....	54
Axle Nut with Split Pin Kit.....	71	6 Stud Braked Stub Axle Complete.....	48
Axle Nut with Washer.....	71	Air Brake 4 Way Valve.....	44
Axle Stud.....	70	Air Brake Adaptor.....	39
Axle Stub Complete.....	45	Air Brake Coil Handles.....	39
Fiat Braked Suspension Axle.....	56	Air Brake Coupling C-Type Female.....	44
		Air Brake Coupling C-Type Male.....	43
		Air Brake Drain Valve.....	42
		Air Brake Drain Valve With Cable.....	43
		Air Brake Flexi Coil.....	38
		Air Brake Hose.....	38
		Air Brake O-Ring.....	43
		Air Brake Plug Fitting.....	42
		Air Brake Reusable Fittings.....	41
		Air Brake Reusable Fittings 90°.....	42
		Air Brake Stud Fittings.....	40
		Air Brake Stud Fittings 90°.....	41
		Air Brake Test Point.....	43
		Air Brake Thrust Ring.....	43
		AL-KO Compact Braked Hand Winch 450.....	91
		AL-KO Detachable Braking Cable.....	34
		Anti-kink Air Brake Flexi Coil.....	38
		Brake Cable Bracket.....	35
		Braking Cable.....	34
		End Mounted Air Brake Reservoir.....	37
		Fiat Braked Hub.....	48
		Fiat Braked Suspension Axle.....	56
		Fiat Braked Suspension Unit.....	59
		Fiat High Speed Solid Braked Axle.....	55
		Hydra-Safe Braking System.....	33
		Inner Air Brake Adaptor.....	39
		Land Rover 1500kg High Speed	
		Solid Braked Axle.....	55
		Internal Spring Brake Ram.....	94
		Land Rover Braked Suspension Axle.....	56
		Palm Type Air Brake Coupling.....	44
		Ratchet Lever Trailer Parking Brake.....	35
		Ratchet Parking Brake.....	35
		Stepped Bulkhead Air Brake Adaptor.....	40
		Strap Mounted Air Brake Reservoir.....	37
		Straight Bulkhead Air Brake Adaptor.....	40
		Trailer Braking Ram.....	94
		Trailer Brake Single Spring Ram Assembly.....	94
		Type 2 Parking Brake.....	35
		<b>Brake Shoe Set</b>	
		AL-KO Style Auto Reverse Axle Brake	
		Shoe Sets.....	33
		Auto Reverse Axle Brake Shoe Sets.....	33
		Brake Shoe Spring Sets.....	34
		Hub Brake Shoe Sets.....	34
		<b>Bumper Protection</b>	
		Stainless Steel Bumper Protector.....	24
		<b>Bushion</b>	
		Hitch Eye Reducer Bushion.....	16
		<b>Cable</b>	
		AL-KO Detachable Braking Cable.....	34
		Avonride Safety Cable.....	14
		Bradley Breakaway Cable Kit.....	8
		Brake Cable Bracket.....	35
		Braking Cable.....	34
		LED 3 Function Rectangular Cable Kit.....	87
		<b>Cargo</b>	
		4 Hole Cargo Tie Down.....	78
		6 Hole Cargo Tie Down.....	78
		Bolt-on Cargo Tie Down Delta Ring.....	78
		Cargo Tie Down D-Ring.....	78
		Trailer Cargo Net.....	82
		Weld-on Cargo Tie Down Delta Ring.....	79
		<b>Catch Box</b>	
		Catch Box.....	80
		Catch Box Pin.....	73
		<b>Chain</b>	
		1 Leg Tested Safety Chain.....	91
		Pin & Chain.....	73
		Round Pin & Chain.....	73
		Spring Type Pin & Chain.....	73
		Trailer Safety Chain.....	25
		<b>Coil</b>	
		Air Brake Coil Handles.....	39
		Air Brake Flexi Coil.....	38
		Anti-kink Air Brake Flexi Coil.....	38
		Drawbar Spring.....	61

**Cover**

Spiral Guard Cover.....93

**Coupling**

2700kg Cast Coupling Head.....11  
 3500kg Cast Coupling Head.....12  
 1300kg Coupling Damper.....12  
 2700kg Coupling Damper.....13  
 3500kg Coupling Damper.....13  
 1400kg Pressed Steel Coupling Head.....9  
 2000kg Pressed Steel Coupling Head.....9  
 Air Brake Coupling C-Type Female.....44  
 Air Brake Coupling C-Type Male.....43  
 AL-KO AK7 750kg Coupling Head.....2  
 Avonride/Knott 3500kg Coupling Bellows.....14  
 Bradley HU3 Coupling Head Kit.....5  
 Bradley HU12 Coupling Head Kit.....5  
 Coupling Head Lock Kit.....12  
 Coupling Skid 70mm.....61  
 Double Pin Slider Plate Coupling 100mm.....24  
 Double Pin Slider Plate Coupling 150mm.....25  
 Flange Spoon Coupling.....18  
 Genfitt 2,600kg Coupling Damper Kit.....7  
 Genfitt 1700kg Coupling Damper Kit.....6  
 Genfitt 2000kg Coupling Damper.....12  
 Genfitt 2600kg (95+) Coupling Damper Kit.....7  
 Genfitt 2700kg Coupling Damper.....13  
 Genfitt 3500kg Coupling Damper.....13  
 Genfitt 3500kg Coupling Damper Kit.....7  
 Knott BQ-27 750kg Cast Coupling Head.....9  
 Palm Type Air Brake Coupling.....44

**Damper**

1300kg Coupling Damper.....12  
 2700kg Coupling Damper.....13  
 3500kg Coupling Damper.....13  
 Bradley 255 Damper Kit.....6  
 Bradley 259 Damper Kit.....6  
 Bradley 260 Damper Kit.....7  
 Bradley 3220 Damper Kit.....7  
 Genfitt 2,600kg Coupling Damper Kit.....7  
 Genfitt 1700kg Coupling Damper Kit.....6  
 Genfitt 2000kg Coupling Damper.....12  
 Genfitt 2600kg (95+) Coupling Damper Kit.....7  
 Genfitt 2700kg Coupling Damper.....13  
 Genfitt 3500kg Coupling Damper.....13  
 Genfitt 3500kg Coupling Damper Kit.....7

**Dixon Bate**

Dixon Bate DB201691 Dual Towing  
 Ball 3.5 Ton.....20  
 Dixon Bate DB202014 Dual Towing  
 Ball 3.5 Ton.....20  
 Dixon Bate Dual Towing Ball Pin.....20

**Drain**

Air Brake Drain Valve.....42  
 Air Brake Drain Valve With Cable.....43

**Dumbbell**

Double Side Roller Dumbbell With Tube.....84  
 Side Roller Dumbbell.....83

**Fasteners**

ACME Ramp Fastener.....80  
 Ramp Fastener Complete.....81  
 Ramp Fastener Plate.....81

**Fiat**

Axle Grease Cap For Fiat Hub.....64  
 Fiat 4-Stud Wheel Assembly.....66  
 Fiat Auto-Reverse Hub & Cable.....48  
 Fiat Braked Hub.....48  
 Fiat Braked Suspension Axle.....56  
 Fiat Braked Suspension Unit.....59  
 Fiat High Speed Solid Braked Axle.....55  
 Fiat High Speed Solid Unbraked Axle.....54  
 Fiat Unbraked High Speed Hub.....45  
 Fiat Unbraked Hub.....46  
 Fiat Unbraked Suspension Unit.....58  
 Fiat Unbraked Suspension Axle.....57

**Filter**

Inline Filter.....44

**Fittings**

Air Brake Plug Fitting.....42  
 Air Brake Reusable Fittings.....41  
 Air Brake Reusable Fittings 90°.....42  
 Air Brake Stud Fittings.....40  
 Air Brake Stud Fittings 90°.....41

**Fixing**

Flange Type Fixing Plates.....18  
 Flange Type Fixing Screws.....18

**Flange**

Flange Hitch Eye Rigid.....17  
 Flange Hitch Eye Swivel.....17  
 Flange Spoon Coupling.....18  
 Flange Towball 3 Ton (3000Kg).....21  
 Flange Type Fixing Screws.....18  
 Hole Flange Type Fixing Plates.....18  
 Jockey Wheel Complete With Flange Bracket..28

**Ford**

Ford Auto-Reverse Hub & Cable.....49  
 Ford Unbraked Hub.....46

**Forket**

Forket with Plate.....79

**Gudgeon**

Bolt-On Gudgeon BZP.....75  
 Weld-On Gudgeon.....75  
 Weld-On Gudgeon BZP.....75

**Grease Cap**

ACE Series Grease Cap.....63  
 ATV Hub Grease Cap.....62  
 Axle Grease Cap.....64  
 Axle Grease Cap For Fiat Hub.....64  
 Grease Cap.....62  
 N-Series Grease Cap.....63  
 Push-In Grease Cap.....62  
 PVC Mini Hub Grease Cap.....62  
 R-Series Grease Cap.....63  
 Screw-In Grease Cap.....62  
 Steel Mini Hub Grease Cap.....63  
 VT-Series Grease Cap.....63

**Guard**

Spiral Guard Cover.....93

**Handle**

Air Brake Coil Handles.....39  
 Bradley Pad 3349 & Handle Kit.....6  
 Bradley Pad 3350 & Handle Kit.....5  
 Clamp Handle.....14

**Head**

2700kg Cast Coupling Head.....11  
 3500kg Cast Coupling Head.....12

1400kg Pressed Steel Coupling Head.....9  
 2000kg Pressed Steel Coupling Head.....9  
 AL-KO AK7 750kg Coupling Head.....2  
 Bradley HU3 Coupling Head Kit.....5  
 Bradley HU12 Coupling Head Kit.....5  
 Coupling Head Lock Kit.....12  
 Knott BQ-27 750kg Cast Coupling Head.....9

**Hiace**

Hiace Auto-Reverse Hub & Cable.....49  
 Hiace Unbraked Hub.....46

**Hinge**

Double Slot BZP Hinge.....76  
 Long Hinge.....76  
 Self Colour Forged Hinge.....76  
 Single Slot BZP Hinge.....76  
 Straight Hinge.....75

**Hitch**

2000kg Avonride Hitch.....10  
 2700kg Avonride Hitch.....10  
 3500kg Avonride Hitch.....11  
 Avonride Black Hitch Bellows.....14  
 Avonride Red Hitch Bellows.....13

Blue Double Duty Hitch 1.5 Ton (1,500 Kg).....22  
 Blue Double Duty Independent Hitch  
 1.5 Ton (1,500 Kg).....22  
 Bradley D30 Spring Damped Hitch.....2  
 Bradley D40 Spring Damped Hitch.....3  
 Bradley D60 Spring Damped Hitch.....3  
 Bradley D201 Unbraked Hitch.....2  
 Bradley HU3 2000kg Hydratow Delta Hitch.....3  
 Bradley HU3 2700kg Hydratow Delta Hitch.....4  
 Bradley HU12 3500kg Hydratow Delta Hitch.....4  
 Dual Towing Ball & Pin Hitch.....21  
 Hitch Pin with Rope & Clip.....21  
 Heavy Duty Black Double Duty Hitch 2 Ton  
 (2,000 Kg).....22

**Hitch Eye**

14 Ton Flat Hitch Eye.....15  
 25 Ton Flat Hitch Eye.....16  
 32 Ton Flat Hitch Eye.....16  
 Cranked Hitch Eye.....15  
 Flange Hitch Eye Rigid.....17  
 Flange Hitch Eye Swivel.....17  
 Hitch Eye Reducer Bushion.....16  
 Short Flat Hitch Eye.....15  
 Standard Flat Hitch Eye.....15  
 Swivel Hitch Eye.....16

**Hook**

Bolt-On Rope Hook.....77  
 Bolt-On Rope Hook Zinc Plated.....77  
 Lifting Hook With Clevis & Locking Pin.....92  
 Lifting Hook With Clip.....91  
 Lightweight Rope Hook.....77  
 Locking Bar Hook.....79  
 Weld-On Rope Hook S/C.....77

**Hose**

Air Brake Hose.....38  
 Anti Burst Hose Sleeve.....93  
 R2AT Hydraulic Hose.....93

**Hub**

ATV Hub Grease Cap.....62  
 Auto Reverse 4 Stud 5.5inch PCD Hub Set 1500kg...51  
 Auto Reverse 4 Stud 100mm PCD Hub Set 900kg...50  
 Auto Reverse 4 Stud 100mm PCD Hub Set 1500kg...50  
 Auto Reverse 4 Stud 108mm PCD Hub Set 1500kg...51  
 Auto Reverse 4 Stud 115mm PCD Hub Set 1500kg...52  
 Auto Reverse 5 Stud 112mm PCD Hub Set 900kg...52  
 Auto Reverse 5 Stud 112mm PCD Hub Set 1500kg...53  
 Auto Reverse 5 Stud 115mm PCD Hub Set 1500kg...53  
 Axle Grease Cap For Fiat Hub.....64  
 Fiat Auto-Reverse Hub & Cable.....48  
 Fiat Braked Hub.....48  
 Fiat Unbraked High Speed Hub.....45  
 Fiat Unbraked Hub.....46  
 Ford Auto-Reverse Hub & Cable.....49  
 Ford Unbraked Hub.....46  
 Hiace Auto-Reverse Hub & Cable.....49  
 Hiace Unbraked Hub.....46  
 Hub Brake Shoe Sets.....34  
 Land Rover 750kg Auto-Reverse Hub & Cable .....49  
 Land Rover 900kg Auto-Reverse Hub & Cable.....49  
 Land Rover Unbraked Hub.....46  
 PVC Mini Hub Grease Cap.....62  
 Steel Mini Hub Grease Cap.....63  
 Unbraked Mini Hub.....47

**Hydrasafe**

Hydra-Safe Braking System.....33

**Hydraulic**

Air/Hydraulic Actuator.....36  
 BSP 2 Piece Swage Female Insert.....93  
 Double Acting Hydraulic Hand Pump.....95  
 Heavy Duty Double Acting Hydraulic Ram.....94  
 Hydraulic Ball Valve.....95  
 Hydraulic Box Jack.....31  
 Hydraulic Flow Regulator Check Valve.....95  
 Hydraulic Pressure Gauge.....95  
 Inline Safety Check Male Valve.....93  
 R2AT Hydraulic Hose.....93  
 Standard Duty Double Acting Hydraulic Ram.....94

**Jockey Wheel**  
 Auto Folding Jockey Wheel..... 26  
 FC242 Bracket - 48MM..... 29  
 FC242 Jockey Wheel Complete..... 26  
 TJ11 Jockey Wheel..... 26  
 TJ11 Jockey Wheel Bracket - 35MM..... 29  
 TJ12 Jockey Wheel..... 27  
 TJ12 Jockey Wheel Bracket - 42MM..... 29  
 TJ12 Jockey Wheel with Bracket..... 27  
 TJ15 Jockey Wheel..... 27  
 TJ15S Jockey Wheel..... 28  
 TJ15S Jockey Wheel Bracket - 48MM..... 29  
 Jockey Wheel Complete With Flange Bracket..... 28  
 Jockey Wheel Complete with Pneumatic Wheel..... 27  
 Wheel Assembly For FC242 Jockey Wheel..... 30  
 Wheel Assembly For TJ11 Jockey Wheel..... 30  
 Wheel Assembly For TJ12 Jockey Wheel..... 30  
 Wheel Assembly For TJ15S Jockey Wheel..... 30

**Junction Box**  
 BRITAX 10 Way Junction Box..... 90

**Keel**  
 Keel Roller..... 83  
 Keel Roller Bracket..... 84  
 V-Keel Roller..... 83

**Knott-Avonride**  
 1400kg Pressed Steel Coupling Head..... 9  
 2000kg Pressed Steel Coupling Head..... 9  
 2700kg Cast Coupling Head..... 11  
 3500kg Cast Coupling Head..... 12  
 1300kg Coupling Damper..... 12  
 2700kg Coupling Damper..... 13  
 3500kg Coupling Damper..... 13  
 Avonride Black Hitch Bellows..... 14  
 Avonride Hitch 2000kg..... 10  
 Avonride Hitch 2700kg..... 10  
 Avonride Hitch 3500kg..... 11  
 Avonride/Knott 3500kg Coupling Bellows..... 14  
 Avonride Red Hitch Bellows..... 13  
 Avonride Safety Cable..... 14  
 Clamp Handle..... 14  
 Coupling Head Lock Kit..... 12  
 Knott BQ-27 750kg Cast Coupling Head..... 9

**Land Rover**  
 5-Stud Land Rover Wheel Assembly..... 68  
 Land Rover 750kg Auto-Reverse Hub & Cable..... 49  
 Land Rover 900kg Auto-Reverse Hub & Cable..... 49  
 Land Rover 1500kg High Speed Solid Braked Axle..... 55  
 Land Rover Braked Suspension Axle..... 56  
 Land Rover Unbraked Hub..... 46

**Leaf Spring**  
 Leaf Spring..... 60  
 Leaf Spring Bracket..... 60  
 Leaf Spring U-Bolt Kit..... 60  
 Leaf Spring U-Bolt Only..... 61

**Lighting**  
 LED 3 Function Rectangular Cable Kit..... 87  
 LED 45° Left Hand Marker Lamp..... 89  
 LED Bolt On Compact Flexible Beacon..... 89  
 LED Fog Lamp..... 88  
 LED GLO-TRAC Rectangular Rear Lamp Set..... 87  
 LED Magnetic Lighting Set..... 87  
 LED Mudguard Marker Lamp..... 88  
 LED Number Plate Lamp With Cable & Studs..... 88  
 LED Rectangular Rear Combi Lamp..... 88  
 LED Reversing Lamp..... 88  
 LED Round Rear Combi Lamp..... 87  
 LED Trailer Lighting Board (4ft x 5m)..... 87

LED Rectangular Rear Combi Lamp..... 88  
 LED Reversing Lamp..... 88  
 LED Round Rear Combi Lamp..... 87  
 LED Trailer Lighting Board (4ft x 5m)..... 87  
 LED Varivolt Amber Side Lamp SM20..... 89  
 LED Varivolt Clear Front Lamp FM20..... 89  
 LED Warning Aluminium Strobe..... 90  
 LED Warning Double Strobe..... 89  
 LED Warning Surface Strobe..... 89  
 Trailer Lighting Board (4ft x 5m)..... 87

**Lifting**  
 Lifting Chain Grade 80..... 91  
 Lifting Hook With Clevis & Locking Pin..... 92  
 Lifting Hook With Clip..... 91  
 Weld On Lifting Point..... 92

**Lock**  
 Bracket for Locking Bar..... 80  
 Bradley Lock-it..... 8  
 Cop Trailer Lock..... 25  
 Coupling Head Lock Kit..... 12  
 Lifting Hook With Clevis & Locking Pin..... 92  
 Locking Bar Hook..... 79  
 Locking Bar Tab..... 79

**Lug**  
 Trailer Lug..... 79

**Mudguard**  
 Double PVC Mudguard Pairs..... 82  
 Double PVC Mudguard Singly..... 82  
 Single PVC Mudguard..... 82

**Net**  
 Trailer Cargo Net..... 82

**Nut**  
 Axle Nut..... 71  
 Axle Nut with Split Pin Kit..... 71  
 Axle Nut with Washer..... 71  
 Clonical Wheel Nut Kit..... 72  
 Pinball Nut..... 23  
 Spherical Nut Kit Metric SB011..... 71  
 Spherical Nut Kit Metric SB053..... 71  
 Spherical Nut Kit UNF SB010..... 72

**Pad**  
 Boat Trailer Hull Support Pad..... 85  
 Bradley Pad 3349 & Handle Kit..... 6  
 Bradley Pad 3350 & Handle Kit..... 5

**Parking**  
 Ratchet Lever Trailer Parking Brake..... 35  
 Ratchet Parking Brake..... 35  
 Type 2 Parking Brake..... 35

**Peg**  
 Slotted Peg..... 74

**Pin**  
 Catch Box Pin..... 73  
 Dual Towing Ball & Pin Hitch..... 21  
 Hitch Pin with Rope & Clip..... 21  
 Lifting Hook With Clevis & Locking Pin..... 92  
 Pin & Chain..... 73  
 Round Pin & Chain..... 73  
 Spring Type Pin & Chain..... 73  
 Tow Pin..... 90

**Plate**  
 Anti-Luce Plate..... 75  
 Double Pin Slider Plate Coupling 100mm..... 24

Double Pin Slider Plate Coupling 150mm..... 25  
 Forket with Plate..... 79  
 Ramp Fastener Plate..... 81  
 Trailer Drop Plate - Universal..... 61

**Plug**  
 7 Pin PVC Plug..... 90  
 Air Brake Plug Fitting..... 42

**Power Pack**  
 12V Double Acting Power Pack  
 With Remote & 7L Tank..... 95  
 12V Single Acting Power Pack  
 With Remote & 7L Tank..... 95

**Pressure Gauge**  
 Hydraulic Pressure Gauge..... 95

**Pulley**  
 Stainless Steel Pulley With Swivel Eye..... 92

**Pump**  
 Double Acting Hydraulic Hand Pump..... 95

**Ram**  
 4 Stage Heavy Duty Trailer Ram..... 94  
 Heavy Duty Double Acting Hydraulic Ram..... 94  
 Internal Spring Break Ram..... 94  
 Standard Duty Double Acting  
 Hydraulic Ram..... 94  
 Trailer Braking Ram..... 94  
 Trailer Brake Single Spring Ram Assembly..... 94

**Ramp**  
 ACME Ramp Fastener..... 80  
 Straight Aluminium Ramp..... 86  
 Curved Aluminium Ramp..... 86  
 Ramp Fastener Complete..... 80  
 Ramp Fastener Plate..... 81  
 Ramp Door Sprin..... 81

**Ratchet & Tie Down**  
 4 Hole Cargo Tie Down..... 78  
 6 Hole Cargo Tie Down..... 78  
 Bolt-on Cargo Tie Down Delta Ring..... 78  
 Cargo Tie Down D-Ring..... 78  
 Grade 80 Loadbinder..... 92  
 Weld-on Cargo Tie Down Delta Rin..... 79  
 Ergonomic Ratchet Lashing..... 91  
 Ratchet Lashing..... 91

**Reflectors**  
 Clear Round Reflector..... 88

**Reservoir**  
 End Mounted Air Brake Reservoir..... 37  
 Strap Mounted Air Brake Reservoir..... 37

**Rim**  
 4-Stud Wheel Rim 4in & 100mm PCD..... 69  
 4-Stud Wheel Rim 5.5in PCD..... 69  
 5-Stud Wheel Rim 112mm & 165.1mm PCD..... 69  
 5-Stud Wheel Rim 165.1mm PCD..... 69

**Roller**  
 Double Side Roller Dumbbell With Tube..... 84  
 Side Roller Bracket With Tube..... 84  
 Side Roller Dumbbell..... 83  
 Single Side Assembly Roller with Tube..... 84  
 Single Side Roller..... 83  
 Keel Roller..... 83  
 Keel Roller Bracket..... 84  
 Parallel Side Roller..... 83  
 V-Keel Roller..... 83



**Rope**  
 Bolt-On Rope Hook.....77  
 Bolt-On Rope Hook Zinc Plated..... 77  
 Lightweight Rope Hook..... 77  
 Roll of Galvanised Wire Rope..... 92  
 Weld-On C-Type Rope Hook.....77  
 Weld-On Rope Hook S/C..... 77

**Scharmuller**  
 Flange Hitch Eye Rigid.....17  
 Flange Hitch Eye Swivel.....17  
 Flange Spoon Coupling.....18  
 Flange Type Fixing Screws.....18  
 Flange Type Fixing Plates.....18

**Service Kit**  
 Bradley 107 Bellows Service Kit.....8  
 Bradley 2039 Bellows Service Kit.....8

**Shackle**  
 Zinc Plated Shackles.....92

**Skid**  
 Coupling Skid 70mm.....61

**Sleeve**  
 Anti Burst Hose Sleeve.....93

**Socket**  
 7 Pin PVC Socket.....90

**Spacer**  
 Towball Spacer Block.....23

**Spring**  
 Bradley D30 Spring Damped Hitch.....2  
 Bradley D40 Spring Damped Hitch.....3  
 Bradley D60 Spring Damped Hitch.....3  
 Bradley Trigger Spring.....6  
 Brake Shoe Spring Sets.....34

Drawbar Spring.....61  
 Internal Spring Break Ram.....94  
 Leaf Spring.....60  
 Leaf Spring Bracket.....60  
 Leaf Spring U-Bolt Kit.....60  
 Leaf Spring U-Bolt Only.....61  
 Ramp Door Spring.....81  
 Spring Type Pin & Chain.....73  
 Torsion Spring.....81  
 Trailer Brake Single Spring Ram Assembly.....94

**Stud**  
 Axle Stud.....70  
 Wheel Stud Kit SB017.....70  
 Wheel Stud Kit SB055.....70

**Suspension**  
 175kg Mini Suspension Unit.....59  
 250kg Mini Suspension Unit.....59  
 AL-KO Unbraked Suspension Axle.....57  
 Fiat Braked Suspension Axle.....56  
 Fiat Braked Suspension Unit.....59  
 Fiat Unbraked Suspension Unit.....58  
 Fiat Unbraked Suspension Axle.....57  
 Unbraked Suspension Unit 500kg.....58  
 Unbraked Suspension Unit 750kg.....58

**Tab**  
 Locking Bar Tab.....79

**Towing**  
 Bradley E40TC Towing Jaw 3.5 Ton.....19  
 Bradley E100TC Towing Jaw 3.5 Ton.....19

Bradley E100T Towing Jaw 3.5 Ton..... 19  
 Dixon Bate DB201691 Dual Towing Ball 3.5 Ton..... 20  
 Dixon Bate DB202014 Dual Towing Ball 3.5 Ton..... 20  
 Dual Towing Dual Ball Pin..... 20  
 Dual Towing Ball & Pin Hitch.....21  
 Flange Towball 3 Ton (3000Kg).....21  
 Long Series Towball.....23  
 Short Series Towball.....23  
 Towball Spacer Block.....23  
 Tow Pin.....90

**Trailer**  
 ATV Trailer Kit..... 70  
 Boat Trailer Guide.....103  
 Cattle Trailer Guide.....104  
 Dump Trailer Guide..... 106

**Tyres & Tubes**  
 Road Tyre.....72  
 Tyre Tube.....72

**Unbraked**  
 6-Stud 400mm Unbraked Stub Axle Complete.....45  
 AL-KO 4-Stud 100mm Unbraked High Speed Axle Stub Complete.....45  
 AL-KO Unbraked Suspension Axle.....57  
 Bradley D201 Unbraked Hitch.....2  
 Fiat High Speed Solid Unbraked Axle.....54  
 Fiat Unbraked High Speed Hub.....45  
 Fiat Unbraked Hub.....46  
 Fiat Unbraked Suspension Unit.....58  
 Fiat Unbraked Suspension Axle.....57  
 Ford Unbraked Hub.....46  
 Hiace Unbraked Hub.....46  
 Land Rover Unbraked Hub.....46  
 Unbraked Mini Hub.....47  
 Unbraked Mini Axle Stub.....47  
 Unbraked Suspension Unit 500kg.....58  
 Unbraked Suspension Unit 750kg.....58

**Valve**  
 Air Brake 4 Way Valve.....44  
 Air Brake Drain Valve.....42  
 Air Brake Drain Valve With Cable.....43  
 Burst Valve.....93  
 Eco Load Sensing Relay Valve.....36  
 Eco Standard Relay Valve.....37  
 Hydraulic Ball Valve.....95

Hydraulic Flow Regulator Check Valve.....95  
 Inline Safety Check Male Valve.....93  
 Manual Load Proportioning Valve.....36  
 Shunt Valve.....44  
 Wabco Load Sensing Relay Valve.....36

**Wheel**  
 4-Stud Knobby Tyre Wheel Assemblies.....67  
 4-Stud 4 Ply Road Tyre Wheel Assembly.....67  
 4-Stud Wheel Assembly 145/80 R10 74N.....65  
 4-Stud Wheel Assembly 145 R10C 84/82N.....65  
 4-Stud Wheel Assembly 4.80/4.00-8.....65  
 4-Stud Wheel Assembly 500/10 72M.....65  
 4-Stud Wheel Assembly 155/80 R13 84N.....66  
 4-Stud Wheel Assembly 165 R13C 96-94N.....66  
 4-Stud Wheel Rim 4IN & 100MM PCD.....69  
 4-Stud Wheel Rim 5.5IN PCD.....69  
 5-Stud Land Rover Wheel Assembly.....68  
 5-Stud Wheel Assembly 6.50 R16 108-107N.....68  
 5-Stud Wheel Assembly 185/60 R12C 104/102N.....68  
 5-Stud Wheel Assembly 185 R14C 104-102N.....68

5-Stud Wheel Assembly 185 R14C 104-102N.....68  
 5-Stud Wheel Rim 112MM & 165.1MM PCD.....69  
 5-Stud Wheel Rim 165.1MM PCD.....69  
 Boat Trailer 4-Stud Wheel Assembly.....67  
 Clonical Wheel Nut Kit.....72  
 FC242 Jockey Wheel Complete.....26  
 Fiat 4-Stud Wheel Assembly.....66  
 Jockey Wheel Complete with Bracket.....28  
 Jockey Wheel Complete with Pneumatic Wheel.....27  
 Mini 4-Stud Wheel Assembly.....66  
 TJ11 Jockey Wheel.....26  
 TJ11 Jockey Wheel Bracket - 35MM.....29  
 TJ12 Jockey Wheel.....27  
 TJ12 Jockey Wheel Bracket - 42MM.....29  
 TJ12 Jockey Wheel with Bracket.....27  
 TJ15 Jockey Wheel.....27  
 TJ15S Jockey Wheel.....28  
 TJ15S Jockey Wheel Bracket - 48MM.....29  
 Mini 4-Stud Wheel Assembly.....66  
 Mud/Sand Wheel Assembly.....67  
 Wheel Assembly For FC242 Jockey Wheel.....30  
 Wheel Assembly For TJ11 Jockey Wheel.....30  
 Wheel Assembly For TJ12 Jockey Wheel.....30  
 Wheel Assembly For TJ15S Jockey Wheel.....30  
 Wheel Bearing Kit SB005.....64  
 Wheel Stud Kit SB017.....70  
 Wheel Stud Kit SB055.....70

**Weld On**  
 Weld-On Anti-Luce.....74  
 Weld-On Baby Anti-Luce.....74  
 Weld-on Cargo Tie Down Delta Ring.....79  
 Weld-On Gudgeon.....75  
 Weld-On Gudgeon BZP.....75  
 Weld On Lifting Point.....92  
 Weld-On C-Type Rope Hook.....77  
 Weld-On Rope Hook S/C.....77

**Winch**  
 AL-KO Compact Braked Hand Winch 450.....91

**Wire**  
 Roll of Galvanised Wire Rope.....92

DK630024003.....7  
 DK630028011.....12  
 DK630028012.....13  
 DK630028013.....13  
 DK630028014.....7  
 DK630824030.....7  
 DK630824035.....6  
 G773.....92  
 G878.....92  
 G924.....91  
 G978.....91  
 G2069.....93  
 G2735.....90  
 G2739.....90  
 G2748.....87  
 G2803.....88  
 G2912A.....74  
 G2913.....74  
 G2914.....74  
 G2915.....74  
 G2916.....74  
 G2918.....73  
 G2919.....73  
 G2920.....74  
 G2921.....75  
 G2923.....75  
 G2924.....75  
 G2927.....75  
 G2928.....75  
 G2929.....76  
 G2930.....76  
 G2931.....76  
 G2934A.....76  
 G2934B.....76  
 G2936.....81  
 G2937.....80  
 G2939.....81  
 G2940.....80  
 G2941.....81  
 G2942.....81  
 G2943.....81  
 G2944.....81  
 G2945.....81  
 G2947.....15  
 G2948.....15  
 G2949.....15  
 G2950.....15  
 G2951A.....15  
 G2951B.....16  
 G2951C.....16  
 G2952.....79  
 G2953.....79  
 G2954.....73  
 G2955.....79  
 G2956.....79  
 G2957.....73  
 G2990.....76  
 G2992.....76  
 G2994.....77  
 G2994A.....77  
 G2997.....77  
 G2997A.....77  
 G3000.....73  
 G3000A.....80  
 G3001.....79  
 G3001A.....79  
 G3002.....79  
 G3002A.....79  
 G3003.....80  
 G3003A.....80  
 G3027.....2  
 G3027A.....8  
 G3029A.....25  
 G3032A.....2  
 G3033A.....3  
 G3034.....3  
 G3042C.....4  
 G3043A.....8  
 G3043B.....8  
 G3044.....23  
 G3045.....23  
 G3046.....23  
 G3047.....22  
 G3049.....22  
 G3050.....21

G3050A.....23  
 G3050B.....22  
 G3051.....4  
 G3052.....3  
 G3057.....26  
 G3057A.....29  
 G3058.....27  
 G3058A.....29  
 G3058B.....27  
 G3059.....28  
 G3060.....29  
 G3062.....26  
 G3063.....29  
 G3064.....30  
 G3065.....30  
 G3070.....31  
 G3070A.....31  
 G3071.....31  
 G3072.....60  
 G3073.....60  
 G3074.....60  
 G3075.....60  
 G3075A.....60  
 G3076.....60  
 G3077.....47  
 G3078.....46  
 G3079.....46  
 G3080.....46  
 G3081.....45  
 G3082.....48  
 G3083.....48  
 G3086C.....47  
 G3087.....59  
 G3088.....59  
 G3090.....59  
 G3091.....59  
 G3094.....66  
 G3095.....67  
 G3096.....66  
 G3097.....66  
 G3098.....68  
 G3100N.....68  
 G3109A.....60  
 G3110.....60  
 G3111.....60  
 G3113A.....61  
 G3112.....81  
 G3112A.....81  
 G3114.....84  
 G3115.....83  
 G3116.....84  
 G3117.....83  
 G3118.....84  
 G3119.....83  
 G3120.....83  
 G3121.....84  
 G3122.....83  
 G3127.....85  
 G3130.....85  
 G3131.....85  
 G3132.....84  
 G3133.....85  
 G3135.....75  
 G3136.....80  
 G3138.....81  
 G3139.....81  
 G3140.....81  
 G3143.....15  
 G3144.....15  
 G3145.....15  
 G3146.....15  
 G3147.....77  
 G3151.....81  
 G3152.....81  
 G3154.....6  
 G3157.....23  
 G3158.....23  
 G3159.....25  
 G3166.....60  
 G3167.....82  
 G3168.....82  
 G3168A.....82  
 G3168B.....82  
 G3168C.....82  
 G3182.....46

G3183.....49  
 G3184.....49  
 G3185.....49  
 G3186.....49  
 G3187A.....34  
 G3187B.....34  
 G3773A.....95  
 G3895.....94  
 G3938.....94  
 G3939.....94  
 G3953.....95  
 G4099.....90  
 G8722.....72  
 G8729.....67  
 G8730.....67  
 G8734.....72  
 G8735.....72  
 G8736.....72  
 G8737.....72  
 G8740.....72  
 G8935A.....61  
 G8940.....54  
 G11051.....45  
 G11053.....48  
 G11096.....70  
 G11097.....71  
 G11099.....71  
 G12103.....10  
 G12104.....10  
 G12105.....11  
 G12193.....94  
 G12297.....81  
 G12434.....33  
 G12435.....33  
 G12438.....64  
 G12439.....64  
 G12441.....64  
 G12442.....64  
 G12443.....72  
 G12444.....71  
 G12445.....72  
 G12450.....70  
 G12452.....34  
 G12455.....34  
 G12459.....71  
 G12460.....63  
 G12461.....63  
 G12462.....63  
 G12463.....63  
 G12464.....35  
 G12467.....12  
 G12468.....14  
 G12469.....14  
 G12471.....12  
 G12473.....13  
 G12474.....13  
 G12475.....14  
 G12476.....13  
 G12478.....9  
 G12479.....11  
 G12480.....12  
 G12484.....72  
 G12485.....71  
 G12667.....7  
 G12668.....7  
 G12669.....6  
 G12674.....5  
 G12690.....81  
 G12702.....34  
 G12703.....34  
 G12705.....70  
 G12706.....71  
 G12707.....70  
 G12710.....64  
 G12711.....64  
 G12712.....64  
 G12746.....16  
 G12747.....16  
 G12859.....91  
 G13139.....93  
 G13254.....56  
 G13255.....56  
 G13256.....56  
 G13257.....57  
 G13258.....55  
 G13259.....54

G13260.....	55	G17797.....	78	G18564.....	33
G13261.....	55	G17798.....	78	G18579.....	87
G13273.....	27	G17799.....	78	G18586.....	17
G13289.....	5	G17800.....	78	G18587.....	18
G13290.....	5	G17823.....	20	G18588.....	17
G13446.....	64	G17826.....	62	G18589.....	18
G13513.....	30	G17843.....	61	G18590.....	18
G13546.....	9	G17887.....	35	G18591.....	18
G13552.....	48	G18089.....	9	G18602.....	95
G13553.....	49	G18109.....	89	G18613.....	93
G13554.....	49	G18118.....	2	G18765.....	93
G13555.....	49	G18166.....	36	G18774.....	93
G13556.....	49	G18167.....	36	G18844.....	89
G13557.....	34	G18168.....	36	G18853.....	89
G13560.....	70	G18183.....	40	G18860.....	90
G13801.....	70	G18184.....	40	G18979.....	91
G13804.....	64	G18185.....	40	G19043.....	92
G13805.....	34	G18186.....	40	G19047.....	92
G13972.....	6	G18190.....	42	G19050.....	92
G14045.....	80	G18211.....	93	G19129.....	32
G14064.....	60	G18219.....	94	G19130.....	32
G14120.....	6	G18282.....	90	G19131.....	32
G14400.....	58	G18324.....	78	G19132.....	32
G14401.....	58	G18325.....	79	G19133.....	28
G14409.....	59	G18361.....	33	G19183.....	35
G14410.....	59	G18362.....	33	G19291.....	92
G14614.....	71	G18363.....	33	G19356.....	34
G14668.....	64	G18388.....	42	G19357.....	34
G14669.....	64	G18390.....	42	G19409.....	95
G14670.....	62	G18394.....	41	G19445.....	70
G14671.....	70	G18395.....	41	G19469.....	67
G14863.....	77	G18397.....	41	G19470.....	67
G14864.....	77	G18401.....	41	G19472.....	65
G14868.....	76	G18402.....	41	G19473.....	65
G15004.....	31	G18403.....	41	G19474.....	65
G15008.....	21	G18405.....	41	G19475.....	65
G15009.....	20	G18406.....	41	G19476.....	68
G15029.....	75	G18407.....	40	G19477.....	66
G15053.....	63	G18408.....	40	G19478.....	66
G15057.....	76	G18409.....	40	G19479.....	68
G15058.....	75	G18410.....	42	G19480.....	68
G15511.....	70	G18411.....	42	G19481.....	69
G15623.....	16	G18413.....	44	G19482.....	69
G15806.....	62	G18414.....	43	G19483.....	69
G15807.....	62	G18415.....	44	G19484.....	69
G16184.....	30	G18416.....	44	G19485.....	69
G16254.....	14	G18417.....	37	G19486.....	69
G16399.....	19	G18418.....	37	G19487.....	69
G16400.....	19	G18419.....	36	G19488.....	69
G16401.....	19	G18421.....	44	G19489.....	69
G16476.....	62	G18422.....	44	G19492.....	65
G16537.....	68	G18423.....	43	G19516.....	25
G16617.....	21	G18424.....	43	G19518.....	24
G16988.....	26	G18427.....	39	G19519.....	58
G16989.....	70	G18428.....	38	G19520.....	58
G16993.....	23	G18429.....	38	G19521.....	57
G17141.....	35	G18430.....	38	G19522.....	50
G17202.....	94	G18431.....	38	G19523.....	52
G17207.....	61	G18432.....	38	G19524.....	50
G17208.....	61	G18433.....	38	G19525.....	51
G17212.....	24	G18434.....	38	G19526.....	53
G17213.....	78	G18435.....	38	G19527.....	51
G17214.....	78	G18436.....	38	G19528.....	52
G17215.....	89	G18437.....	38	G19529.....	53
G17216.....	89	G18438.....	39	G19530.....	82
G17220.....	88	G18447.....	31	G19531.....	82
G17225.....	88	G18448.....	31	G19532.....	82
G17227.....	88	G18467.....	43	G19533.....	82
G17228.....	88	G18468.....	43	G19534.....	86
G17237.....	87	G18469.....	43	G19535.....	86
G17238.....	88	G18470.....	43	G19536.....	86
G17241.....	89	G18471.....	40	G19537.....	86
G17445.....	23	G18472.....	40	G19543.....	45
G17461.....	62	G18473.....	39	G19544.....	34
G17514.....	27	G18474.....	39	G19545.....	34
G17632.....	91	G18475.....	44	G19546.....	34
G17698.....	61	G18478.....	37	G19547.....	34
G17740.....	61	G18479.....	36	G19548.....	34
G17750.....	87	G18490.....	67	G19549.....	34
G17753.....	87	G18511.....	43	G19550.....	33
G17765.....	81	G18514.....	90	G19551.....	33
G17783.....	20	G18527.....	87	G19552.....	33
G17787.....	95	G18531.....	91	G19735.....	82
G17788.....	95	G18560.....	14	G19736.....	82
G17791.....	15	G18562.....	33	G19737.....	82
		G18563.....	33	G19738.....	82



**GENERATIONS OF KNOWLEDGE  
AT YOUR SERVICE**

**Genfitt Mayo Ltd.  
Knock Road  
Kiltimagh  
Co. Mayo  
F12 K732**

**+353 (0) 94 938 1377**

**[info@genfitt.ie](mailto:info@genfitt.ie)**

**[www.genfitt.ie](http://www.genfitt.ie)**